

# 2023

## Bridge Improvement Grant (BIG) Procedure



South Dakota

Department of Transportation

Office of Local Government Assistance

5/26/22

## Local Bridge Improvement Grant (BIG) Procedure

I.	Objective .....	3
II.	Definitions .....	3
III.	Funding Responsibilities.....	10
IV.	Screening Criteria .....	11
V.	Selection Process.....	14
VI.	Scoring Criteria.....	16
	A. Preliminary Engineering and Rehabilitation/Replacement Grants.....	16
	B. Preservation Grants.....	19
VII.	Project Development Requirements Following Grant Award.....	20
	A. For Preliminary Engineering Studies .....	21
	B. For All Bridge Preservation Treatments .....	21
	C. For All Bridge Rehabilitation/Replacements.....	23
VIII.	Reimbursement Process .....	24
IX.	Sign .....	25
X.	Application Submittal.....	25
XI.	Grant Management.....	26
	Appendix A - Survey and Hydraulic Work Order Requirements, TS&L Report, Foundations .....	A1-A30
	Appendix B - Structure Design Work Order Requirements.....	B1-B3
	Appendix C - Structure Preservation or Rehabilitation Work Order Requirements .....	C1-C10
	Appendix D – Construction Engineering Requirements.....	D1-D9
	Appendix E - Bridge Improvement Grant Sign Layout .....	E1-E2
	Appendix F - Bridge Improvement Grant Checklists .....	F1-F4

# Local Bridge Improvement Grant (BIG) Procedure

## I. Objective:

In 2015, the South Dakota Legislature created the Bridge Improvement Grant (BIG) fund that provides \$7 million for local government bridges derived from an increase in license plate fees. In addition, the South Dakota Department of Transportation (SDDOT) will add \$26 million in state funds, for a total of \$33 million made available in the bridge grant program for the 2023 cycle of grants. The objective of these procedures is to define how these BIG bridge funds will be recommended for award and administered. Funding for the BIG program is not intended to be used for expansion of infrastructure with creation of new routes on new alignments.

## II. Definitions

**ADT** - Value of average daily traffic on the bridge. This item will be based on the data in National Bridge Inventory Item 29.

**Bid Review Ready** – For preservation or rehabilitation/replacement projects, a project application is bid review ready if it contains final, internal consultant review and complete plans ready for DOT review (with scope complete as per Appendix B or C), including all necessary certifications (utility, right-of-way, and any others that are required), wetland mitigation proposals, and permits (404, Stormwater, Railroad, etc.). If the project is to be let by Local Public Agency (LPA) instead of SDDOT, the application must also include an Engineer's Estimate, Bid Proposal, Specifications, and Construction Management Plan to be considered review ready.

**Bridge** - As defined in the National Bridge Inspection Standards (NBIS): A structure, including supports, erected over a depression or an obstruction, as water, highway, or railway, the structure having a length measured along the center of the roadway of more than twenty feet between undercopings of abutments or extreme ends of openings for multiple boxes and pipes where the clear distance between openings is less than half of the smaller contiguous opening. Refer to the following examples.

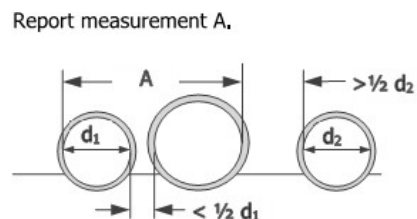
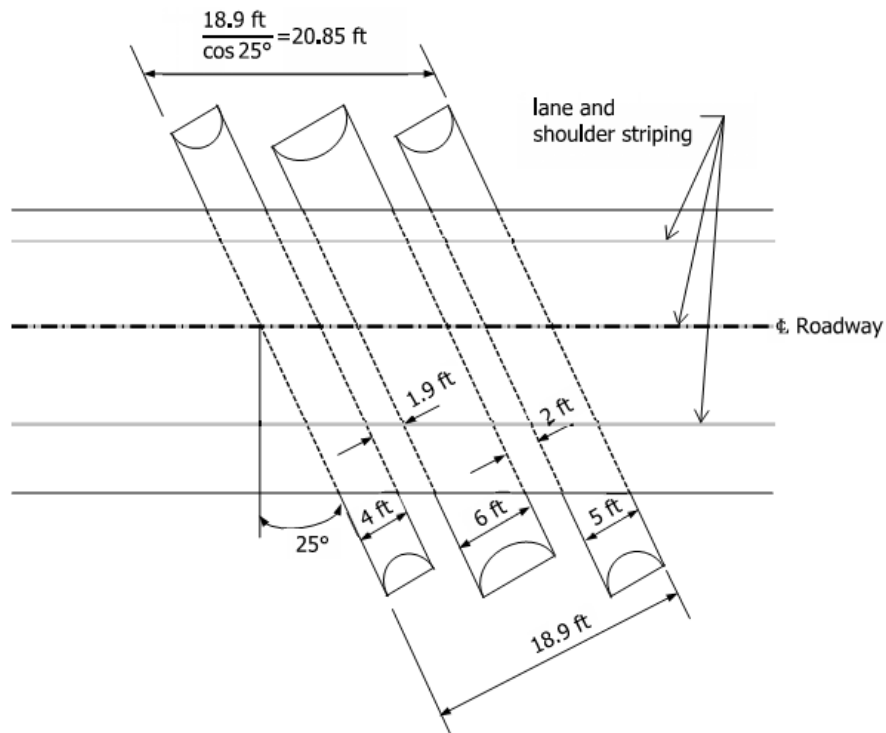
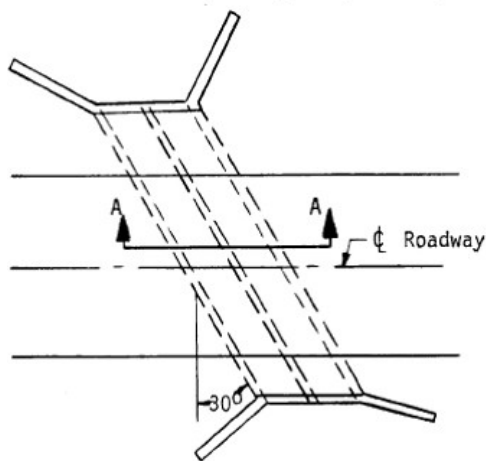

Figure 17. Profile view of a multi-pipe culvert under fill.

# Local Bridge Improvement Grant (BIG) Procedure



Multiple pipes may be considered a bridge if the distance between the pipes is less than half of the smallest opening and the structure length is greater than 20 feet. In the above illustration, the structure length is recorded as 20.85 feet.



Measurement for a skewed box under fill.

# Local Bridge Improvement Grant (BIG) Procedure

Report measurement A.

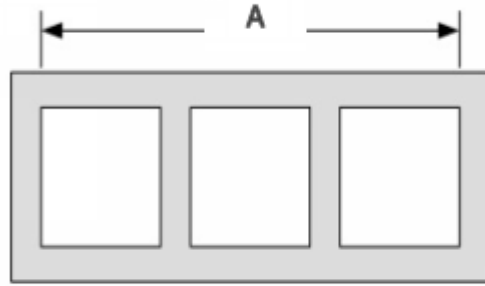

Figure 16. Profile view of a four-sided, multi-cell culvert under fill.

Report measurement A.

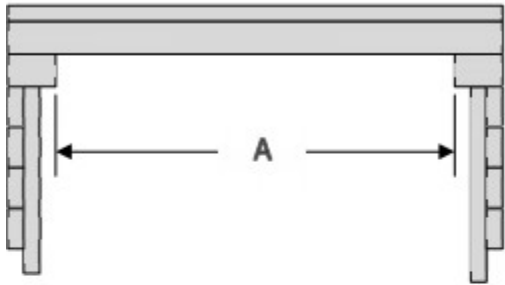

Figure 14. Profile view of a single span bridge with pile bent abutments.

Report measurement A.

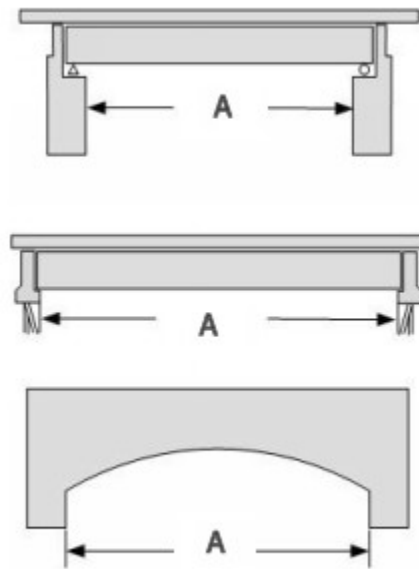

Figure 15. Profile views of various single span bridges.

## Local Bridge Improvement Grant (BIG) Procedure

**Bridge Improvement Grant (BIG)** – Grant available to LPA for preliminary engineering, bridge preservation, structure replacement or major rehabilitation.

**Bridge Preservation** – Actions or strategies that prevent, delay or reduce deterioration of bridges or bridge elements, restore the function of existing bridges, keep bridges in good or fair condition and extend their service life. Preservation actions may be cyclic or condition-driven.

**Condition rating** - The condition rating of a bridge as reported in the national bridge inventory.

**Construction Engineering** – Administration, oversight, and testing of all construction activities by SDDOT or an engineer listed on the SDDOT retainer contract list for the Construction Administration work type. Construction Engineering costs are eligible for grant funds at 80% of actual costs, but are not included in the grant cap.

**Culvert Condition** – Condition rating of culvert. This rating will be based on the data in National Bridge Inventory item 62.

**Deck Condition** – Condition rating of the part of the structure that carries traffic. This rating will be based on the data in the NBI item 58.

**Detour Length** - Minimum additional length of travel required if the bridge in question was closed. Detour route shall be located on a full maintenance road and must allow passage of a legal weight, height, and width vehicle. The NBI detour length for an on-system bridge will be based on the location of the nearest on-system route that will allow the legal load to pass. For an off-system bridge, the detour length will be based on the nearest route that will allow passage for the legal load. NBI detour lengths are determined as impact to through traffic only (points A to B in Figure 102 and 103). User impact will be based on actual length as reported in the NBI. If detour length in the NBI is listed as "99" (indicates greater than 100 miles, or is a dead end), further investigation by SDDOT is required to ensure that an appropriate detour length is used. Refer to following for examples:

Highway feature carried on the bridge with a 4-mile detour (*Figure 102*). Report 4.

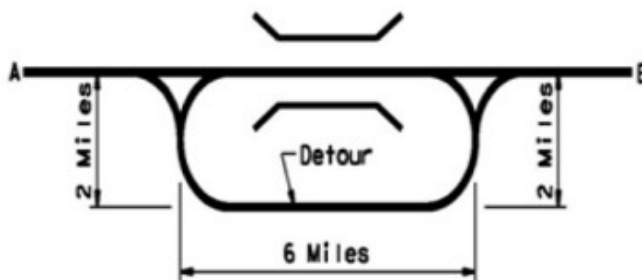

Figure 102. Detour map for a highway feature carried on the bridge.

## Local Bridge Improvement Grant (BIG) Procedure

Highway feature passes below the bridge with a 0-mile detour (*Figure 103*). Report 0.

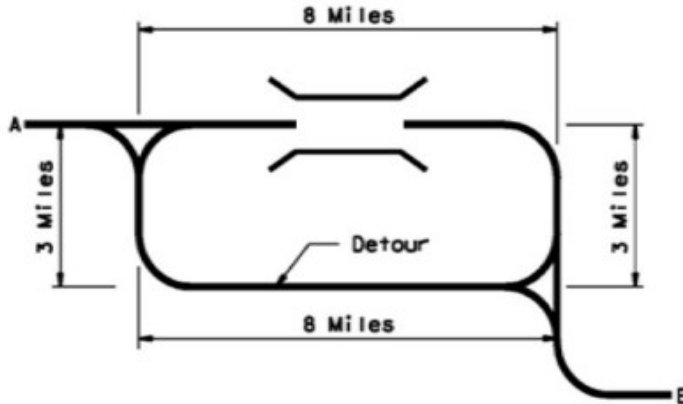

Figure 103. Detour map for a highway feature that passes below the bridge.

**DOT Format (Required on all Engineer's Cost Estimates)** – Cost plus fixed fee (Maximum allowable fixed fee rates: Preliminary Engineering & Replacement Projects – 13%, Preservation & Rehabilitation Projects – 14%.)

**Engineer's Cost Estimate** – A cost estimate of all eligible items projected to the anticipated year of construction and up to a 15% contingency to be included with the BIG application. This amount as reviewed and approved by SDDOT will establish the maximum limiting amount of the grant that will be awarded. Non-eligible items need to be listed separately and not included in the grant amount but are included in the estimated total project costs shown on the application. Lump sum contingency is not eligible if shown as a line item.

**Federal-aid System** – A public highway eligible for assistance from the Federal Highway Administration other than a highway functionally classified as a local road or rural minor collector.

**Full Maintenance Road** – A road on the South Dakota Non- State Public Road Inventory that has not been designated as a Minimum Maintenance Road or a No Maintenance Road.

**Fracture Critical** – Fracture-critical members or member components (FCMs) are steel tension members or steel tension components of members whose failure would be expected to result in a partial or full collapse of the bridge. This designation is based on data in the NBI.

**Local Public Agency (LPA)** – Any local public agency authorized by statute to own, maintain, and govern the use of a bridge.

**Minimum Maintenance Road** – A road that has been lawfully designated by a board of county commissioners or a township board as a minimum maintenance road.

## Local Bridge Improvement Grant (BIG) Procedure

**National Bridge Inventory (NBI)** – A database, compiled by the Federal Highway Administration, with information on all bridges in the United States that have roads passing above or below. If LPAs finds inaccuracies or discrepancies with the data, they should work with their consulting engineer and SDDOT to correct the information recorded in the NBI.

**No Maintenance Road** – A township or county road that has been lawfully designated by a township board or county commission as a no maintenance road.

**Off-System** - Public Roads, other than those on a Federal-aid System.

**On-System** - Public Roads, on a Federal-aid System. This designation will be based on data in NBI item 26.

**PE-BIG** – Grant available to perform preliminary engineering work, including but not limited to preservation/rehabilitation/replacement investigation studies, traffic data collection, surveys, bridge hydrologic/hydraulic (H/H) studies, including the type, location and size recommendation, and foundations investigation.

**Posted** – refers to a bridge that is signed for less than legal loads. This designation will be based on data in NBI item 70.

**Preservation BIG**– Grant for deck replacements, minor repair and preservation work that is within the financial limits set in Section III of this procedure. Examples are scour projects, fatigue retrofits, waterproofing joints, painting, safety upgrade rail/barrier, or deck treatments (such as concrete overlays, polymer overlays, asphalt & membrane overlays, and epoxy chip seals). The goal of a Preservation BIG is to preserve the structure elements and extend the service life of the structure.

**Rehabilitation Projects** – Major repair/rehabilitation work or combination of minor preservation work valued greater than financial limits to be classified as rehabilitation/replacement work as set in Section III of this procedure. Any superstructure (with exception of deck replacements) or substructure repair will be considered a major rehabilitation.

**Replacement Projects** – Total replacement of a bridge.

**Scour Critical** – A bridge with a foundation element that has been determined to be unstable for the observed or evaluated scour condition. This designation is based on NBI appraisal item 113 (Scour) having a value of 3 or less or having unknown foundations.

**Substructure Condition** – Condition rating of the part of the structure that supports the superstructure (piers, bents, abutments). This rating will be based on the data in the NBI item 60.



## Local Bridge Improvement Grant (BIG) Procedure

**Superstructure Condition** – Condition rating of the part of the structure that supports traffic (deck, slab, girders). This rating will be based on the data in the NBI item 59.

**Wheel Tax** – Imposition of a tax by County ordinance as authorized in South Dakota Codified Law Ch. 32-5A on vehicles with a gross vehicle weight of over 6,000 pounds.

### III. Funding Responsibilities

**State Bridge Improvement Grant (BIG) Funds** - Funding will be made available for eligible On and Off-System LPA bridges for preliminary engineering, preservation, rehabilitation, or replacement in accordance with state laws, administrative rules and this Procedure; the funds available for award will be recommended to the Transportation Commission by the SDDOT Director of Planning & Engineering prior to each award. Up to 80 percent of authorized work may be funded through the BIG fund. Requests for deviations from this Procedure will be made upon application and considered at the time of grant award.

**Local Funding Responsibilities** – The LPA will be responsible for a minimum of 20 percent of eligible costs. The LPA will be responsible for 100 percent of ineligible costs, including costs that exceed the grant amount. Right of Way costs, utility relocations, roadway surfacing, fencing, aesthetics, off-site environmental mitigation and monitoring costs, LPA staff wages and expenses, and any costs incurred prior to notice of award date will be considered ineligible. Final determination of eligible costs will be determined prior to any work being performed. SDDOT and the LPA must execute a grant project agreement before any grant funds will be disbursed.

**Limiting Amounts** – To be eligible to apply for a Preservation BIG, anticipated grant expenditures (including engineering) must meet or exceed \$30,000. To be eligible to apply for a BIG for rehabilitation or replacement projects, anticipated grant expenditures (including engineering) must meet or exceed \$100,000. Unless the grant applicant justifies otherwise prior to grant award, engineering hours for a PE-BIG should not exceed 451 hours for small drainage areas (unnamed tributaries/creeks), 601 hours for medium drainage areas (named non-navigable creeks and rivers) and 901 hours for large drainage areas (navigable rivers). In any consecutive three-year period, no LPA may be awarded more than \$8,000,000 in total BIG funds unless the BIG portion of a single structure exceeds this amount. The Director of Planning & Engineering may recommend that the Transportation Commission adjust the limiting amounts prior to each selection process. Refer to Table III-1.

# Local Bridge Improvement Grant (BIG) Procedure

Table III-1

## GRANT LIMITING AMOUNTS

	Grant Amount	Local Match	Total	Limits
PE-BIG	Up to 80% Approved Design Hours	No less than 20% Approved Design Hours	100% Approved Design Hours	<451 hours – small drainage areas (unnamed tributaries/creeks) <601 hours – medium drainage areas (named creeks/rivers) <901 hours – large drainage areas (navigable rivers)
Preservation BIG	\$30,000	\$7,500	\$37,500	Minimum
Rehab/Repl. BIG	\$100,000	\$25,000	\$125,000	Minimum
	\$8,000,000	Maximum total BIG funds in a consecutive 3-year period		

### IV. Screening Criteria

SDDOT will perform a preliminary screening of all bridges to determine if the bridges meet the minimum requirements of the BIG program. This preliminary screening does not guarantee eligibility or award. Any application that does not meet the minimum requirements will not be scored or ranked and will be recommended for rejection. SDDOT may verify accuracy of the data within the NBI for the qualified bridges. The SDDOT and LPA may correct any inaccuracies identified in the review of each BIG application.

Bridges owned by cities and towns are eligible for BIG funding. Bridges owned by private individuals, development groups, Federal Agencies, state agencies, or Tribes are not eligible.

To be eligible for a BIG, County owned bridges must be listed on the “Project Listing” in that County’s Highway and Bridge Improvement Plan as approved by SDDOT. The County must also have imposed a wheel tax.

The following screening criteria will be considered in the BIG award process:

#### A. All Projects:

1. **Bridge Function** – Bridge must serve multiple residences, farms, ranches or a multi-lot development. The bridge cannot be located on a “No Maintenance” or a “Minimum Maintenance Road”, and the roadway served by the bridge cannot terminate into a field entrance, a driveway, single residence, farm, or ranch.

## Local Bridge Improvement Grant (BIG) Procedure

2. **NBIS (National Bridge Inspection Standards)** - LPA must be in full compliance with Federal and State inspection requirements including but not limited to posting of load restrictions.
3. **Five-Year County Highway and Bridge Improvement Plan** – A county must have a SDDOT approved transportation plan and the bridge must be in the County’s 5-year plan. (This requirement does not apply to cities and towns.)
4. **Wheel Tax** – A county in which the bridge is located must have an active wheel tax imposed on the residents of the county for vehicles with a gross vehicle weight of more than 6,000 pounds.
5. **Bridge Status** – No bridge can be under contract or advertised for bid for any type of improvement at the time of the grant award.

### B. PE-BIG

1. **Cost of Project** – Total costs, including engineering, fall within the requirements as established in Section III of this procedure.
2. **General Maintenance** – The LPA must show proof of general maintenance on the bridge, including a description of all work performed, a list of materials costs incurred, a statement regarding whether reoccurring maintenance items have appeared on inspection forms, and any other pertinent maintenance information.

### C. Preservation BIG

1. **Cost of Project** – Total costs, including design, construction and construction engineering fall within the requirements, as established in Section III of this procedure.
2. **Extends Service Life** – Project is projected to extend the service life by at least 10 years.
3. **General Maintenance** – The LPA must show proof of general maintenance on the bridge, including a description of all work performed, a list of materials costs incurred, a statement regarding whether reoccurring maintenance items have appeared on inspection forms, and any other pertinent maintenance information.

**For Bridge Deck Overlays** – Bridge deck overlays will be considered based on criteria set out in Table IV-1 and the general criteria that follow the table.

**Bridge Deck Replacements** – Bridge deck replacements will be considered for

## Local Bridge Improvement Grant (BIG) Procedure

Preservation BIG under this grant program. Deck replacements may be considered when the condition of the deck exceeds the criteria for successful overlays. Both substructure and superstructure must be in good or fair condition for consideration of a deck replacement with a Preservation BIG.

Table IV-1  
General Criteria

#New Polymer Overlay	Structure Age	No restriction
	Deck Condition	Element Condition State 1 or 2** <5% Delamination***
New Concrete Overlay	Structure Age	< 50 years*
	Deck Condition	Element Condition State 1 or 2** < 10% Delamination***
	Deck Thickness	≥ 6.75" and >1" clear cover of resteel
Replacement Concrete Overlay (2 <sup>nd</sup> or 3 <sup>rd</sup> Overlays)	Overlay Age	20 or more years*
	Overlay Condition	Element Condition State 3 or 4**
	Substrate (Deck/Slab)	Element Condition State 1 or 2

Structures submitted for new Rigid Concrete Overlays must also be checked for impact on Load Capacity prior to applying for grant funds.

All overlay applications should include a delamination survey. Generally, polymer overlay projects should be limited to locations where the bridge is subject to chloride applications.

\* Structure age is only a general guideline. Structures outside of these age parameters can be considered if they are in good condition or if joints can be eliminated (eliminate simple spans). **For replacement concrete overlays, overlay condition and substrate condition are the critical factors.**

\*\* American Association of State Highway Transportation Officials (AASHTO) Element Condition States

\*\*\* Bridge deck delamination:

- If less than 5% delamination/spalls - Candidate for polymer chip seal
- If less than 10% and more than 5% - Candidate for a concrete overlay
- If greater than 10% - further evaluation of total bridge life, life cycle cost, etc.

# New polymer overlays have also been used to seal badly cracked concrete overlays and new slabs/decks with epoxy coated resteel that have a significant cracking problem, too extensive for individual crack repair.

## Local Bridge Improvement Grant (BIG) Procedure

### D. Rehabilitation and Replacement BIG

1. **Cost of project** – Total costs, including design, construction and construction engineering fall within the requirements, as established in Section III of this procedure.
2. **Bridge Condition and Alternatives** – Bridges must be classified in poor condition (NBI Condition Rating of 4 or less for Deck, Superstructure, Substructure, or Culvert) to be eligible for rehabilitation or replacement. All bridges must be evaluated for potential rehabilitation prior to any consideration for replacement. The condition, age, structure type, scour criticality, and potential preservation or rehabilitation alternatives shall be reviewed for each bridge. The feasibility of those alternatives and the economics of replacement versus rehabilitation shall be considered. Generally, when the rehabilitation costs are estimated at 60% or more of the replacement costs, then replacement may be justified. Existing bridge removal with a no-build is a viable option for this category.
3. **General Maintenance** – The LPA must show proof of general maintenance on the bridge, including a description of all work performed, a list of materials costs incurred, a statement regarding whether reoccurring maintenance items have appeared on inspection forms, and any other pertinent maintenance information.

### V. Selection Process

The SDDOT will conduct the BIG selection process annually. PE-BIG applications are due August 1 of each calendar year. The Transportation Commission will consider these applications by October 30 of the same year. Pre-applications for Preservation grants, if submitted, are due by September 1 of each calendar year. Applications for Preservation, Rehabilitation and Replacement grants are due by January 2 of the following year and will be considered by the Transportation Commission by April 30 of that year.

#### A. Preliminary Engineering Bridge Improvement Grant (PE-BIG)

1. A bridge that meets Section IV criteria of this procedure may be eligible for a PE-BIG grant.
2. LPA will complete and submit application to SDDOT by August 1 each year for eligible

## Local Bridge Improvement Grant (BIG) Procedure

bridge(s).

3. SDDOT's recommendation of award of PE-BIG grants will be based on available funding and the scoring process as detailed in Section VI.

### **B. Preservation Bridge Improvement Grant (Preservation BIG)**

1. For a Preservation BIG, LPA may submit a pre-application that details a bridge's preservation needs as determined by LPA's Bridge Inspection Engineer. Included in the pre-application are a draft application form, site map, most recent inspection report, and a one-page description of the proposed preservation treatment. Advantages of submitting a pre-application would be for collaboration on preservation recommendations for the project scope. An example would be proposing a deck seal treatment vs. a deck-overlay vs. a deck replacement.
2. The SDDOT will determine if a site visit is needed to review the proposed preservation treatment and recommend modifications.
3. LPA will complete and submit final application to SDDOT by January 2 of each year, for eligible bridges.
4. Applications should include all pertinent information including maps, photos, inspection reports, delamination surveys, and information relating to the preservation treatments being recommended so that adequate information is available for the ranking process. A detailed engineer's cost estimate showing design costs, construction costs, and construction engineering costs, shall also be included with the application.
5. SDDOT's recommendation of award of Preservation BIGs will be based on available funding, the scoring process as detailed in Section VI, and SDDOT's determination of project feasibility and constructability and whether the proposed project addresses structural deficiencies.

### **C. Bridge Improvement Grant (BIG) for Bridge Rehabilitation or Replacement**

1. LPA will complete and submit application to SDDOT by January 2 of each year, for eligible bridge(s).
2. LPA's application must include the Type, Size, and Location (TS&L) report (see

## Local Bridge Improvement Grant (BIG) Procedure

Appendix A), and a detailed engineer's cost estimate showing design costs, construction costs, and construction engineering costs.

3. SDDOT will use current inventory condition reports at the time of final application review for the scoring process in Section VI.
4. SDDOT's recommendation of award of BIGs for rehabilitation or replacement will be based on available funding, the scoring process as detailed in Section VI, and SDDOT's determination of project feasibility and constructability and whether the proposed project addresses structural deficiencies.

### VI. Scoring Criteria

#### A. Preliminary Engineering and Rehabilitation/Replacement Grants

SDDOT will use engineering judgment when applying the following scoring criteria to rank the competing qualified applications:

##### 1. Bridge Condition (50 points maximum)

- a) **Posted** (28 points maximum) – See the definition of “Posted” in the definitions section. Points will be awarded in accordance with Table VI-1.

Table VI-1

Bridge Inventory Code	Relationship of Operating Rating to Maximum Legal Load	Ranking Points
5	NO POSTING REQUIRED	0
4	0.1 TO 9.9% BELOW	6
3	10.0 TO 19.9% BELOW	12
2	20.0 TO 29.9% BELOW	18
1	30.0 TO 39.9% BELOW	24
0	> 39.9% BELOW	28

- b) **Substructure Condition** (6 points maximum) – See the definition of “Substructure Condition” in the definitions section of this Procedure. Points will be awarded in accordance with Table VI-2.
- c) **Superstructure Condition** (6 points maximum) – See the definition of “Superstructure Condition” in the definitions section of this Procedure. Points will be



## Local Bridge Improvement Grant (BIG) Procedure

awarded in accordance with Table VI-2.

Table VI-2

NBI Condition Rating	Ranking Points
>5	0
5	1
4	2
3	3
2	4
1	5
0	6

- d) **Culvert Condition** (12 points maximum) – See the definition of “Culvert Condition” in the definitions section of this Procedure. Points will be awarded at two times the value as shown in Table VI-2.
- e) **Fracture Critical** (5 points or zero points) – See the definition of “Fracture Critical” in the definitions section of this Procedure. Five points will be awarded if the structure is determined to be fracture critical.
- f) **Scour Critical** (5 points or zero points) – See the definition of “Scour Critical” in the definitions section of this Procedure. Five points will be awarded if the structure is determined to be scour critical.
- 2. User Impact** (20 points maximum) - User Impact will be a variable that measures impact on users of the bridge and will be calculated by multiplying the ADT for the bridge by the Detour Length. The points will be assigned based on the following formulas with the maximum value for user impact capped at 20 points:
- $$\text{User Impact (On-System)} = \text{ADT} \times \text{Detour Length (miles)} / 350$$
- $$\text{User Impact (Off-System)} = \text{ADT} \times \text{Detour Length (miles)} / 100$$
- 3. Local Planning** (30 points maximum for counties/ 20 points for cities)
- a) **Wheel Tax** (10 points maximum) – See the definition of “Wheel Tax” in the definitions section of this Procedure. Points will be awarded to counties in accordance with Table VI-3, based on imposition of a wheel tax on vehicles with a gross vehicle weight of

## Local Bridge Improvement Grant (BIG) Procedure

6,000 pounds or greater. This section does not apply to cities.

Table VI-3

Assessment / Wheel	Points
\$5	10
\$4-\$4.99	Actual \$ Amount x 2
\$3-\$3.99	Actual \$ Amount x 2
\$2-2.99	Actual \$ Amount x 2
\$1-1.99	Actual \$ Amount x 2
\$0-\$0.99	0

b) **Bid Review Ready (10 points or zero points)** – See the definition of “Bid Review Ready” in the definitions section of this Procedure. For rehabilitation or replacement projects, 10 points will be awarded if the project is Bid Review Ready.

c) **LPA Financial Commitment (10 points maximum)** – For any LPA cost share beyond the required 20%, additional points will be awarded as shown in Table VI-4.

Table VI-4

BIG Share (%)	LPA Share (%)	Points
80	20	0.00
79	21	0.33
78	22	0.67
77	23	1.00
76	24	1.33
75	25	1.67
74	26	2.00
73	27	2.33
72	28	2.67
71	29	3.00
70	30	3.33
69	31	3.67
68	32	4.00
67	33	4.33
66	34	4.67
65	35	5.00
64	36	5.33

## Local Bridge Improvement Grant (BIG) Procedure

63	37	5.67
62	38	6.00
61	39	6.33
60	40	6.67
59	41	7.00
58	42	7.33
57	43	7.67
56	44	8.00
55	45	8.33
54	46	8.67
53	47	9.00
52	48	9.33
51	49	9.67
50 or less	50 or more	10.00

- 4. City Scoring (90 points maximum)**– City points will be prorated to a 100-point system to align with other LPA projects.

### **B. Preservation Grants**

SDDOT will use engineering judgment when applying the following Scoring Criteria to rank the competing qualified applications:

- 1. User Impact (5 points maximum)** - User Impact is a variable that measures the impact on the users of the bridge and will be calculated by multiplying the ADT by the Detour Length. Points will be awarded based on application of the following formulas, with the maximum value for user impact capped at 5 points:
 

$$\text{User Impact (On-System)} = \text{ADT} \times \text{Detour Length (miles)} / 1400$$

$$\text{User Impact (Off-System)} = \text{ADT} \times \text{Detour Length (miles)} / 400$$
- 2. Cost Ratio (10 points maximum)** – If the total estimated cost of bridge preservation is 60% or more of the total estimated cost of bridge replacement, then 0 points will be awarded. One point will be awarded for every 5% increment below 60%, with a maximum of 10 points awarded.
- 3. Wheel Tax (10 points maximum)** – Points will be awarded to counties in accordance with Table VI-3. This section does not apply to cities.
- 4. LPA Financial Commitment (10 points maximum)** – For any LPA cost share beyond

## Local Bridge Improvement Grant (BIG) Procedure

the required 20%, additional points will be awarded as shown in Table VI-4.

5. **Load Rating (zero, 5, or 10 points)** – If the proposed preservation work is not likely to have an impact to the load rating or will have a negative impact, then 0 points will be awarded. If the proposed preservation work is likely to improve but not eliminate the load rating, then 5 points will be awarded. If the proposed work is likely to remove an existing load restriction, then 10 points will be awarded.
6. **Scour (5 points or zero points)** – If the proposed work addresses scour, 5 points will be awarded.
7. **Substructure Condition (5 points or zero points)** – If the proposed work is likely to improve the substructure condition, then 5 points will be awarded.
8. **Superstructure/Deck Condition (5 points or zero points)** – If the proposed work is likely to improve the superstructure or deck condition, then 5 points will be awarded.
9. **Culvert Condition (10 points or zero points)** – If the proposed work is likely to improve the condition of a culvert, then 10 points will be awarded.
10. **Service Life (20 points or zero points)** – If the proposed work is likely to extend the service life of the structure by more than 10 years, then 20 points will be awarded.
11. **Quality of Project (20 points maximum)** – Up to 20 points may be awarded if the proposed preservation work is an appropriate and effective treatment for the bridge. Consideration will be given to a low sufficiency rating, if the structure is Fracture Critical, if general maintenance has been done on the structure, and overall constructability of the project.
12. **City Scoring (90 points maximum)**– Points for cities will be prorated to a 100-point system to align with other LPA projects.

## VII. Project Development Requirements Following Grant Award

After receiving a grant award, LPA and SDDOT will enter into a grant agreement. LPA will select a professional engineering firm from the current SDDOT consultant retainer list for the applicable category of work. In acquiring any necessary real property interests for the bridge project, the LPA will follow the Uniform Act. The LPA will coordinate any utility notification and relocation. The LPA will also be responsible for any coordination regarding FEMA floodplain

## Local Bridge Improvement Grant (BIG) Procedure

impacts. The SDDOT will review all project plans and the project will not be advertised for bids until LPA receives SDDOT's letting authorization.

Unless the LPA and SDDOT agree otherwise in writing, the following responsibilities will be undertaken by the LPA and SDDOT after grant award:

### **A. For Preliminary Engineering Studies**

#### **1. The LPA will:**

- a) Select a professional engineer from SDDOT Consultant Retainer List for Local Government or State Bridge Design;
- b) Participate in all planning, scoping, and inspection meetings; and
- c) Review and comment on TS&L Report.

#### **2. The SDDOT will:**

- a) Hire the LPA selected consulting firm for preliminary engineering;
- b) Invite LPA to all planning, scoping, and inspection meetings;
- c) Submit draft TS&L to LPA for review and comment;
- d) Prepare the final TS&L Report; and
- e) Conduct the foundation investigation and provide recommendations.

### **B. For All Bridge Preservation Treatments**

#### **1. The LPA will:**

- a) Select and hire a professional engineer from SDDOT Consultant Retainer Lists for Local Government or State Bridge Design. Any geotechnical sub-consultants must also be on the SDDOT Consultant Retainer List for Geotechnical Services;
- b) Obtain and submit to SDDOT for comment all bid documents, plans, design calculations, independent check design calculations, hydraulics/hydrology reports, geotechnical/foundation reports, scour analyses reports, load rating and analyses reports for the bridge inspection file (emergency vehicles (where applicable), 3 South Dakota trucks & 4 special haul vehicles (SU4-7) and notional rating load), Construction Management Plan, and specifications sealed and signed by a professional engineer licensed in the State of South Dakota;

## Local Bridge Improvement Grant (BIG) Procedure

- c) Coordinate environmental clearance with U.S. Army Corps of Engineers (USACE), if applicable;
  - d) Obtain all necessary permits (such as USACE 404, DOT, Federal Lands, BIA, Tribal, Stormwater, Municipal, etc.);
  - e) Ensure incorporation of construction engineering and testing requirements in the bid documents;
  - f) Address in writing, to the satisfaction of SDDOT, all SDDOT review comments
  - g) Provide certifications for Right of Way (ROW) acquisition and Utility Notification.
  - h) After receipt of SDDOT letting authorization, advertise the project for bids and conduct bid letting;
  - i) Obtain SDDOT concurrence in the proposed bid award;
  - j) Enter into a construction contract and send a copy to SDDOT;
  - k) Issue the contractor a Notice to Proceed and send a copy to SDDOT;
  - l) Select a construction engineer and enter into an agreement for construction engineering (CE) services which shall include an initial NBI inspection and send a copy to SDDOT;
  - m) Pay construction contractor and consultants in accordance with their contracts with LPA;
  - n) Request reimbursement from SDDOT for eligible expenses based on certified pay application forms; and
  - o) Provide SDDOT as-built plans, construction change orders, and notification of completion of project.
2. The SDDOT will:
- a) Conduct an initial environmental review and provide information and input to the LPA;
  - b) Prior to advertisement for bids, review and offer comments on plans, applicable design calculations, independent design calculation checks, scour analyses, load rating and analyses for the bridge inspection file [emergency vehicles (where applicable), 3 South Dakota trucks & 4 special haul vehicles (SU4-7) and notional rating load], specifications, costs estimates, and bid documents as applicable to the project;

## Local Bridge Improvement Grant (BIG) Procedure

- c) Review and offer comments on the Construction Management Plan for construction testing and inspection; and

### **C. For All Bridge Rehabilitation/Replacements**

#### **1. The LPA will:**

- a) Select and hire a professional engineer from the SDDOT Consultant Retainer List for Local Government or State Bridge Design; any Geotechnical sub-consultants must also be on the SDDOT Consultant Retainer List for Geotechnical Services.
- b) Conduct ROW acquisition and provide ROW certification to SDDOT;
- c) Conduct any required utility notification, relocation, and provide utility certification to SDDOT;
- d) Coordinate with FEMA for any necessary FEMA floodplain map revisions;
- e) Provide any needed wetland or stream mitigation needed for the project;
- f) Obtain all necessary permits (such as USACE 404, DOT, Federal Lands, BIA, Tribal, Stormwater, Municipal, etc.);
- g) Comply with terms as established in the SDDOT Consultant Retainer Contract;
- h) Address in writing, to the satisfaction of SDDOT, all SDDOT review comments;
- i) Obtain and submit to SDDOT for comment all bid documents, plans, design calculations, independent check design calculations, hydraulics/hydrology reports, geotechnical/foundation reports, foundation investigation and recommendations, scour analyses reports, load rating and analyses for the bridge inspection file (emergency vehicles (where applicable), 3 South Dakota trucks & 4 special haul vehicles (SU4-7) and notional rating load), Construction Management Plan, and specifications sealed and signed by a professional engineer licensed in the State of South Dakota;
- j) After receipt of SDDOT letting authorization, advertise the project for bids, and conduct bid letting;
- k) Obtain SDDOT concurrence in the bid;
- l) Enter into a construction contract and send a copy to SDDOT;
- m) Issue the contractor a Notice to Proceed and send a copy to SDDOT;

## Local Bridge Improvement Grant (BIG) Procedure

- n) Select a construction engineer and enter into an agreement for CE services which shall include an initial NBI inspection and send a copy to SDDOT;
  - o) Pay contractor and consultants in accordance with their contracts with LPA;
  - p) Request reimbursement from SDDOT for eligible expenses based on certified pay application forms; and
  - q) Provide SDDOT with construction change orders, copies of tests and certifications, and notification of completion of project.
2. The SDDOT will:
- a) Review and offer comments on structure sheets that show the general drawing, plan/profile and scour measures;
  - b) Review and offer comments on plans, design calculations, independent design calculation checks, scour analyses, load rating and analyses for the bridge inspection file [emergency vehicles (where applicable), 3 South Dakota trucks & 4 special haul vehicles (SU4-7) and notional rating load], specifications, costs estimates, and bid documents as applicable to the project;
  - c) Concur in bid award, if SDDOT deems it appropriate to do so;
  - d) Reimburse LPA for eligible expenses in accordance with the terms and conditions of the grant agreement, and
  - e) Review and offer comments on Construction Management Plan for construction testing and inspection.

### **VIII. Reimbursement Process**

For BIG funding for Preliminary Engineering Grants the SDDOT will bill the LPA for its cost share monthly or quarterly, depending on the volume of work being performed. The LPA cost share will be 20%, unless a different percentage is approved by the Transportation Commission. Eligible costs include SDDOT staff time for preliminary engineering, which will be deducted from BIG reimbursements or billed to the LPA. SDDOT staff time for all preliminary engineering activities would not be included in the grant amount and the required 20% match to the BIG Funds will be paid by SDDOT.



## Local Bridge Improvement Grant (BIG) Procedure

For Preservation Projects and Major Rehabilitation/Replacement Projects, upon receipt of copies of the signed construction contract between the LPA and the contractor and the signed construction engineering contract between the LPA and its construction engineering consultant, the SDDOT will issue payment to the LPA for 75% of the BIG share of the cost of construction and construction engineering for the project. The BIG share will be 80% of eligible items, unless a different percentage is approved by the Transportation Commission. Unless specified differently in the funding agreement, the second and final payment for any remaining eligible grant funds will be reimbursed upon receipt of all Construction Change Orders, contractor final pay requests, and copies of all eligible consultant engineering invoices. SDDOT staff time for all preliminary engineering activities would not be included in the grant amount and the required 20% match to the BIG Funds will be paid by SDDOT.

### **IX. Sign**

Each BIG grant bridge project will be signed with signs as shown in Appendix E. The cost of furnishing and installing the signs is a project expense that may be eligible for BIG reimbursement.

### **X. Application Submittal**

Applications must be submitted to the SDDOT's sftp site or e-mailed to Colton Stahl at [DOT.LOCGOVASSISTOFFICE@state.sd.us](mailto:DOT.LOCGOVASSISTOFFICE@state.sd.us) unless a different e-mail address is designated by SDDOT. If applications are deposited on the state sftp site, e-mail notification must be sent to Colton Stahl. Any requests for deviations from the Procedures must be submitted in writing prior to application deadlines.

Applications for PE grants are due by August 1 of each year. Applications for Preservation, Rehabilitation, and Replacement Grants are due January 2 of each year. Pre-applications for Preservation grants, if submitted, are due by September 1 of each year.

Multiple grant application submittals must be separated into individual pdf files with a limit of

## Local Bridge Improvement Grant (BIG) Procedure

one bridge per application.

### **XI. Grant Management**

The SDDOT Local Government Engineer is responsible for managing the program and making decisions not specifically addressed in this procedure.

## Local Bridge Improvement Grant (BIG) Procedure

### **Appendix A:**

**Survey and Hydraulic Work Order Requirements - A2 thru A6**

**Type, Size, and Location (TS&L) Reports - A7 thru A11**

**Foundation Investigation (Bridges - Ex. 3) - A12 thru A15**

**Undercut Recommendation (Boxes/Pipe - Ex. 4) - A16**

### **Examples Include:**

**Preliminary Hydraulic Data Sheet - A17 thru A18**

**Plan/Profile Sketches and Gradelines - A19 thru A24**

**Drainage Data Sheet and Contour Map - A25 thru A26**

**Photo Documentation and Record Search - A27 thru A30**

# Local Bridge Improvement Grant (BIG) Procedure

## Bridge Improvement Grant Work Order Requirements for Survey and Hydraulics

### SCOPE OF SERVICES TEMPLATE – Survey & Hydraulics

#### Category-Specific Technical Requirements & Provisions, from the Current SDDOT Consultant Retainer, Shall Be Applied

1. **Field survey for completion of the Drainage Data Sheet and Contour Map.** The information required for placement on these sheets is listed below. An example is attached containing the required information.
  - Stationing from south to north or west to east.
  - Beginning and ending stations of the current structure.
  - Proposed and in-place gradelines.
  - Stream profile. (Including a table of stations and elevations for each shot taken.)
  - Sea level datum is required. Stations, elevations, and offsets from and descriptions of permanent objects will be required for project benchmarks. (The High Accuracy Reference Network (HARN) map and the County Bench Mark map for the State of South Dakota can be found at the following web site – <https://dot.sd.gov/doing-business/engineering/design-services/surveyors>)
  - Include an electronic file containing the plan/profile of the in-place gradeline at the structure.
  - Landowners with their addresses, phone numbers, and location of property.
  - Utilities with their addresses, phone numbers, and locations along the project.
  
2. **Field survey as necessary for preparation of construction plans.** Required information is listed below.
  - Establishment of transit points, land ties and benchmarks as well as cross sections and topography. (Stations, elevations, and offsets from permanent objects will be required for project benchmarks.)
  - Project limits as established by consultation with the County Highway Superintendent / City Engineer.
  - Additional legal survey as required for preparation of right-of-way plats.
  - The geometrics of horizontal and vertical alignment in accordance with the Local Roads Plan design standards.
  - Survey notes are to be retained on file with the Consultant for subsequent use in the preparation of construction plans and are to be available to the County/City upon request.

It is anticipated that this item will permit the issuance of a separate work order (after the Type, Size and Location (TS&L) Inspection) for the development of construction plans with no further survey needed.
  
3. **Photo Documentation and Record Search of the Structure as defined in [Attachment #2](#).**
  
4. **Preliminary Hydraulic Data Sheet, Plan/Profile Sketches (Preliminary Hydraulic Layouts) and gradelines, Electronic Copy of the Hydraulic Model, Draft Hydraulic Design Report in accordance with the newest version of the South Dakota Drainage Manual, and cost estimates for existing and all proposed structure alternatives. More than one feasible alternative is required. This includes options on different alignments if applicable. The options need to be acceptable to the owner's future needs and maintenance capabilities. If there is only one type of structure that can reasonably be constructed at a site, simply provide an explanation instead of alternatives.** The newest version of the South Dakota Drainage Manual is available at the following location: <https://dot.sd.gov/doing-business/engineering/design-services/forms-manuals>. Guidance and examples can be found in Chapter 6 of the manual. **The current preliminary hydraulic data sheet to be used can be found in the folder under “000 LGA General Info and Docs” located on the Consultant’s LGA SFTP site.** Directions for filling out the form can be found at the same location. All items will be submitted to the Local Government Assistance Office for distribution to SDDOT personnel for review for compliance with minimum required State and Federal standards. Necessary revisions shall be provided in writing by the SDDOT and shall be forwarded to the Consultant by the Local Government Assistance (LGA) Office. Necessary revisions shall be completed by the consultant and the Revised Draft Hydraulic Design Report submitted within 2 weeks of receipt of revisions from LGA. The Consultant is wholly responsible for the accuracy of the design calculations and the independent check design calculations.

## Local Bridge Improvement Grant (BIG) Procedure

**Note for Box Culverts/Pipe Options and Plans:** The Corps now requires all culverts/pipe where aquatic organism transport is present to have a flow line sunk 1'. If a box/pipe is included in the options, it should be clearly noted that the flowline has been sunk to the required 1'. If the selected structure is a box culvert or pipe, project plans and the final hydraulic data sheet should show that the box or pipe has been sunk to the required 1'.

5. **Conduct TS&L inspection, assistance in the selection of the type, size and location of the replacement structure, and preparation of TS&L summary letter (See Examples #1 & #2 following the attachments).** The county or city (owner) shall be in attendance and advance notice given the Local Government Assistance Office so if time allows, a staff member can attend.
6. **Report of Foundation Investigation.** Conduct field investigation and provide design recommendations according to AASHTO LRFD Bridge Design Specifications Section 10. Report shall include boring information, lab results, and design recommendations. See **Examples #3 and #4, following the attachments**, for reports that are typically developed by SDDOT Geotechnical Engineering Activity.
7. **Obtain Traffic Data.** Conduct field study to obtain 24-hour traffic volumes for existing structure. Data shall be gathered using a mechanical or electronic device. Study shall be conducted on a typical weekday (Tuesday-Thursday) from midnight to midnight. Report of traffic data shall include structure number, counter brand, serial number, date collected, and total volume.
8. **For Structure Chosen at TS&L: Final Hydraulic Design Report, Final Hydraulic Data Sheet (use the current data sheet found in the folder "000 LGA General Info and Docs" located on the LGA SFTP site,) Hydraulic Model with existing and proposed conditions, and if the structure selected is a bridge, Scour Memo summarizing hydraulic scour calculation, Scour Calculation, and Berm Slope Protection Recommendations (if applicable.)**

Please refer to the checklist in **Attachment #1** for the TS&L Packet of items that shall be submitted to the Local Government Assistance Office.

# Local Bridge Improvement Grant (BIG) Procedure

## Attachment #1 Bridge Improvement Grant Checklist for Survey and Hydraulics Work Order TS&L Packet

These items must be submitted to DOT/Local Government Assistance.  
If any of these items are missing, the full packet will be returned for completion and resubmission to this office.

Project Number \_\_\_\_\_ County \_\_\_\_\_ PCN \_\_\_\_\_

Survey Sheets and Contour Map including the following information:

Stationing from south to north or west to east

Beginning and ending stations of the existing structure

Beginning and ending stations of proposed structures

Proposed and existing gradelines

Stream profile and cross sections (Downstream to upstream direction including a table showing stations and elevations for each shot taken)

Elevation and location of buildings and other structures

Survey information using sea level datum and showing station, elevation, offset, and physical description of each project benchmark

Landowner names, addresses, phone numbers, and legal descriptions of their property

Utility names, addresses, phone numbers, and locations along the project

Photo Documentation and Historical Record Search of the Structure (including list of files or repositories searched) as defined in Attachment #2. (In the event that nothing is found, a letter indicating lack of findings, along with files or repositories searched, shall be submitted to the SDDOT/Local Government Assistance Office.)

Preliminary Hydraulic Data Sheet (use current data sheet found in the folder ““000 LGA General Info and Docs” located on the LGA SFTP site) including the following information:

Calculated flows

Inplace conditions (Ordinary High Water Elevation,  $HW_{100}$ ,  $V_{max}$ ,  $OT_{fr}$ )

Proposed conditions for each option ( $HW_2$ ,  $HW_{25}$ ,  $HW_{100}$ ,  $V_{max}$  Qot,  $OT_{fr}$ ,  $E_{Lover}$ top)

Ordinary High Water Elevation Shown on Cross-Sections (vegetation elevation on stream banks – approx. 2-year flow)

Observed High Water Elevation (identifiable high water mark)

Electronic copy of Hydraulic Model of existing and proposed conditions

Plan and profile sketches (preliminary hydraulic layout sheets) for the existing structure and proposed gradelines for each option (More than one feasible alternative is required. This includes options on different alignments if applicable. The options need to be acceptable to the owner's future needs and maintenance capabilities. If there is only one type of structure that can reasonably be constructed at a site, simply provide an explanation instead of alternatives.)

## Local Bridge Improvement Grant (BIG) Procedure

- Cost Estimates (including design and construction engineering and construction costs for each option)
  - Revised Draft Hydraulic Report
- 

TS&L Summary Letter

Report of Foundation Investigation (see Examples 3 and 4 in this appendix)

For Structure Chosen at TS&L

Final Hydraulic Design Report

Final Hydraulic Data Sheet (use current data sheet found in the folder "000 LGA General Info and Docs" located on the LGA SFTP site)

Hydraulic model with existing and proposed conditions

Scour memo, scour calculations, and berm slope protection recommendations (Bridges Only)

# Local Bridge Improvement Grant (BIG) Procedure

## Attachment #2 Local Government Assistance Photo Documentation and Record Search of the Structure

The information defined below will satisfy one of the requirements of the State Historic Preservation Society in clearing the structure for removal.

### Photo Documentation of the Structure

- Site map and photo log of all photos**
- Photos will be taken of: (*at minimum*)**
  - Full views of the structure's primary elevations
  - Close-ups of any decorative, character-defining or structural features
  - General views of the bridge and its environment
- Photos will be labeled as follows:**
  - Photo Number - from photo log and site map
  - Name and Address of property – if property does not have legal address then please note either the Universal Transverse Mercator (UTM) or the legal location down to the quarter section.
  - Month and Year of photograph
  - Description of view, including camera direction (cardinal direction – N, S, E, W)
- Photos will be submitted in one of the following formats:**
  - Digital Photographs
    - At least 2000 X 3000 pixels at 300 dpi
    - Saved as TIFFs submitted on CDs
  - 35mm Black and White Photographs
    - 35mm black/white film printed on black/white photographic paper
    - Both prints and negatives submitted

### Historical Record Search of the Structure

- Any or all of the following are needed:**
  - Reports – maintenance or otherwise indicating modifications to the original structure – what was done and why
  - Any Photographs of the original structure (not inspection photos; not photos referenced in this work order)
  - Original Drawings
  - Original Plans
  - Any other documentation
- Names of Files or Repositories (courthouse, county historical society, etc.) Searched**

If possible, provide the original copy of this information. If not, submit the information in the following format. High quality clear Xerox copies of any reports, drawings, or plans; and photographs scanned at 600 dpi, saved as TIFFs, and submitted on a CD.

If these documents are not otherwise restricted through state or federal law; submit them to the SDDOT/Local Government Office for submission to the South Dakota State Historical Society for public use and reproduction. In the event that nothing is found, a letter indicating lack of findings, along with files or repositories searched, shall be submitted to the SDDOT/Local Government Assistance Office.





**ABC ENGINEERING**

Street Address  
City, State, ZIP  
PHONE / FAX

DATE

ADDRESS BLOCK

RE: BR\_###(00), COUNTY OR CITY, PCN  
STRUCTURE NUMBER, LOCATION

Dear NAME:

A Type, Size, and Location inspection was held on DATE, for the above referenced project. The following personnel were in attendance:

ATTENDEE NAMES, TITLES

The following items were discussed and agreed upon by the inspection participants:

The most applicable structure for this site, based on numerous items discussed during the inspection, is a 63' 1 span precast channel bridge with a 24' deck (22' clear width) and a 30° LHF OR RHF skew. **IF LESS THAN 28' CLEAR ADD THE FOLLOWING SENTENCE** The county has selected a narrower width than the minimum standard as they have no intention of widening the roadway in the future ensuring the structure will not end up being a hazard by being narrower than the roadway. Crown slope of the structure shall be 0.02 ft/ft. The substructure shall consist of steel pile abutments. (Also note bent type if known – such as 2-column bents, etc.) The bridge location will be shown on the Final Hydraulic Data Sheet and will be centered at approximately station 10+00. T101 OR T115 OR SL1 steel rail OR Concrete barrier meeting MASH TL-3 (32") will be shown in the plans. Approach rail will OR will not be needed. Fence anchor eyes will OR will not be provided.

The Contractor will remove and dispose of the existing structure. OR The Contractor will remove and dispose of the existing structure with the exception of the following items to be salvaged for the County OR City: beams, wood planks, and railing. This shall be noted in plans for bidding purposes. Remaining materials shall be disposed of by the Contractor. The abutments and bents shall be removed to 1' below flowline.

The road will be closed during construction with no detour necessary. OR An onsite detour on the DIRECTION side of the structure will be shown in the plans.

Project limits will run from approximately 100' north to 100' south of the structure. The current grade shall be maintained. The typical section will include a crown slope of 0.04 ft/ft (MAY VARY FOR COUNTY) for gravel surfaces OR 0.02 ft/ft for paved surfaces, 4:1 inslopes, 5:1 backslopes, and a standard 10' ditch at 20:1. The approach subgrade shall taper from the structure to match the existing subgrade. The surfacing will consist of gravel OR asphalt, which will be furnished and installed by the County OR City. Clear zone for this site has been set at 10' as per the AASHTO Guidelines for Geometric Design of Very Low-Volume Local Roads OR \_\_\_' as per Table 3.1 of the AASHTO Roadside Design Guide. Unless otherwise noted, all design data for the project will meet the current design speed for the roadway which is ## mph.

**EXAMPLE 1**

**Bridge TS&L Letter Template**

Items to be customized for the specific project and conditions are in blue font. Guidance notes are highlighted.

## Local Bridge Improvement Grant (BIG) Procedure

No channel change and no channel cleanout will be necessary at this site. **OR** No channel change will be necessary at this site. Some channel cleanout of trees and/or brush will be necessary to the northeast and southeast.

The Consultant will provide erosion protection recommendations with the Final Hydraulic Data Sheet. The southwest bank will need to be built up and protected with riprap. (Note location of any out-of-the-ordinary need for riprap and reason why.)

Specific project notes for this project are attached. (ADD ANY PROJECT SPECIFIC NOTES AS ATTACHMENT TO THIS MEMO.)

The Contractor will be responsible for traffic control, topsoiling, and seeding.

The **County OR City** will be responsible for the following items without Grant Participation:

- 1) Right of way and temporary and permanent easements
- 2) Coordination of any utility adjustments
- 3) Furnish and install final surfacing
- 4) Furnish and install temporary and/or permanent fencing
- 5) Remove silt fence in permanently seeded areas

The SDDOT Geotechnical Engineering Activity is requested to provide foundation and backfill recommendations by **DATE (12-18 months from letter date)**. Debris and ice are a known concern at this site. **OR** Debris and ice are not a concern at this site.

The Consultant will provide the name, address, and phone number of adjacent landowners. Utility Company contact information is also needed in the plans for any utilities that exist within the project area. **The DOT Local Government Office (DOT LET) OR the County OR City (LOCALLY LET)** will initiate the 404 permit and other related environmental clearances and will provide the Consultant with materials recommendations if needed.

The Consultant will outline and number the archeological sites on the roadway plan sheet. These sites are located within \_\_\_\_ mile of the structure and cannot be disturbed. Notes stating this shall be placed in the plans and are located with the other project specific notes. These sites will only be labeled in the plans as "Environmentally Sensitive Site #1, 2, 3," etc. No specific identification numbering from SHPO shall be used in the plans to protect these sites from scavenging. **THIS ONLY APPLIES IF SHPO STATES THAT SITES HAVE BEEN FOUND AND MUST BE AVOIDED. DELETE IF NOT NEEDED.**

The letting date will be determined later as it depends on whether this project will be let with local funding or a successful award of a Bridge Improvement Grant for Replacement.

If there are any questions or comments please contact me at **NUMBER**.

Sincerely,

**NAME**  
**TITLE**

Attachment – Drainage Data Sheet & Contour Map for Existing Site & Plan/Profile for Selected Option  
CC: **COUNTY/CITY – CONTACT NAME**  
**LGA – CONTACT NAME**



**ABC ENGINEERING**  
Street Address  
City, State, ZIP  
PHONE / FAX

**EXAMPLE 2**

**Box Culvert/Pipe TS&L Letter  
Template**

Items to be customized for the specific project and conditions are in **blue font**. Guidance notes are **highlighted**.

DATE

ADDRESS BLOCK

RE: BR\_ ###(00), COUNTY, PCN  
STRUCTURE NUMBER, LOCATION

Dear NAME:

A Type, Size, and Location meeting was held on DATE, for the above referenced project. The following personnel were in attendance:

ATTENDEE NAMES, TITLES

The following items were discussed and agreed upon by the inspection participants:

The most applicable structure for this site, based on numerous items discussed during the inspection, is a 5 barrel 12' X 5' cast-in-place **OR** precast RCBC with a 0° RHF **OR** LHF skew, and 0° flared wingwalls at the inlet & 0° flared wingwalls at the outlet. **(REMOVE IF NOT NEEDED.)** As debris and ice are a known concern at this site the center wall(s) will be extended on the inlet. Cutoff wall is to be extended 6" below the recommended outlet protection. The new structure will be centered at approximately sta. 10+07. Fence anchor eyes **will OR will not** be required at this site. The thickness of the bottom slab shall be the same or greater than the thickness of the top slab.

The flowline of the box culvert and riprap to be submerged a minimum of 1' to aid in fish passage. This needs to be documented both on the final hydraulic data sheet and on the structure, general drawing plan sheet. **OR** This location is environmentally sensitive due to the presence of the Topeka Shiner; therefore, the box culvert and riprap will need to be submerged 6" below the flowline to aid migration of the Shiner during its spawning period. This needs to be documented both on the final hydraulic data sheet and on the structure, general drawing plan sheet. **(TOPEKA SHINER SITES NEED TO BE SPECIFICALLY MENTIONED TO INDICATE TO ALL THAT THEY HAVE BEEN IDENTIFIED AT THE SITE AND ACCOMMODATIONS WILL BE MADE.)**

The Contractor shall remove and dispose of the in-place structure. **ADD SPECIFIC SALVAGE ITEMS AS NEEDED** - The Contractor shall salvage the beams, wood planks, and railing for the County, which shall be noted in the plans for bidding purposes. The abutments and bents shall be removed to 1' below flowline.

The project limits shall be from approximately 150' south to 150' north of the structure. The road will be closed with no detour necessary. **Only local traffic will be allowed access.** **OR** An onsite detour on the DIRECTION side of the structure will be shown in the plans.

## Local Bridge Improvement Grant (BIG) Procedure

### **USE THE FOLLOWING Paragraph FOR GRAVEL ROADS (delete if asphalt)**

The typical section will include a crown slope of 0.04 ft/ft (**MAY VARY PER COUNTY**), 4:1 inslopes, 5:1 backslopes, and a standard 10' ditch at 20:1. The surfacing will consist of gravel, which will be furnished and installed by the County. The approach subgrade will taper into the existing. (**IF EXISTING FINISHED SURFACE MEETS OR EXCEEDS LRP MIN. OF 24'**) The length of box shall accommodate the finished surface width of 24' which will match the existing finished surface width. **OR** The length of box shall accommodate the finished surface width of \_\_\_' to ensure the box openings remain outside the clear zone when the roadway is widened. (**OR IF FINISHED WIDTH WILL BE LESS THAN 24' MIN.**) The length of box shall accommodate a finished surface width of \_\_\_'. Although this is narrower than the minimum finished surface width the county has no intention of widening the roadway in the future so the box openings will remain safely outside the clear zone. Clear zone for this site has been set at 10' as per the AASHTO Guidelines for Geometric Design of Very Low-Volume Local Roads **OR** \_\_\_' as per Table 3.1 of the AASHTO Roadside Design Guide. Clear zone is measured from the edge of the traveled way (finished surface) to the inside of the parapet of the box. Unless otherwise stated, all design data for the project will meet the current design speed of the roadway which is \_\_\_mph.

### **USE THE FOLLOWING Paragraph FOR ASPHALT ROADS (delete if gravel)**

The typical section will include a crown slope of 0.02 ft/ft, 4:1 inslopes, 5:1 backslopes, and a standard 10' ditch at 20:1. The surfacing will consist of asphalt, which will be furnished and installed by the County. The approach subgrade will taper into the existing. (**IF PROPOSED MEETS OR EXCEEDS LRP MIN. LANE WIDTH OF 12' AND LRP MIN. SHOULDER WIDTH OF 2'**) The length of box shall accommodate 2-12' driving lanes and 2-2' shoulders to match existing roadway. **OR** The length of box shall accommodate 2-\_\_\_' driving lanes and 2-\_\_\_' shoulders to ensure the box openings remain outside the clear zone when the roadway is widened. (**OR IF FINISHED LANES/SHOULDERS WILL BE LESS THAN MIN.**) The length of box shall accommodate 2-\_\_\_' driving lanes and 2-\_\_\_' shoulders. Although this is narrower than the minimum roadway cross section, the county has no intention of widening the roadway in the future so the box openings will remain safely outside the clear zone. Clear zone for this site has been set at 10' as per the AASHTO Guidelines for Geometric Design of Very Low-Volume Local Roads **OR** \_\_\_' as per Table 3.1 of the AASHTO Roadside Design Guide. Clear zone is measured from the edge of the traveled way (driving lanes) to the inside of the parapet of the box. Unless otherwise stated, all design data for the project will meet the current design speed of the roadway which is \_\_\_mph.

The Consultant will provide inlet and outlet recommendations on the Final Hydraulic Data Sheet. The inlet & outlet protection shall be riprap. **Inlet & outlet aprons shall be concrete. OR At landowner request the aprons will be riprap to prevent cattle from walking through the box culvert.** Any further inlet & outlet protection shall be riprap. (**Any extra riprap needed? If so, where and why?**)

**No channel change and no channel cleanout will be necessary at this site. OR No channel change will be necessary at this site. Some channel cleanout of trees and/or brush will be necessary. A temporary diversion channel will be installed south of the structure.**

The Contractor will be responsible for traffic control, topsoil stripping, and seeding.

The **County OR City** will be responsible for the following items without Grant Participation:

- 1) Right of way and temporary and permanent easements
- 2) Coordination of any utility adjustments
- 3) Furnish and install final surfacing
- 4) Furnish and install temporary and/or permanent fencing
- 5) Remove silt fence in permanently seeded areas

The SDDOT Geotechnical Engineering Activity Office is requested to provide undercut recommendations by **DATE (6 months from letter)**.

## Local Bridge Improvement Grant (BIG) Procedure

The Consultant will provide names, addresses, and phone numbers of the adjacent landowners. Utility Company contact information is also needed in the plans for any utilities that exist within the project area. **(FOR DOT LET PROJECTS) The DOT Local Government Office OR (FOR LOCALLY LET PROJECTS) The County OR City** will initiate the 404 permit and other related environmental clearances and will provide the consultant with materials recommendations.

The Consultant will outline and number the archeological sites on the roadway plan sheet. These sites are located within \_\_\_\_ mile of the structure and cannot be disturbed. Notes stating this shall be placed in the plans and are located with the other project specific notes. These sites will only be labeled in the plans as “Environmentally Sensitive Site #1, 2, 3,” etc. No specific identification numbering from SHPO shall be used in the plans to protect these sites from scavenging. **THIS ONLY APPLIES IF SHPO STATES THAT SITES HAVE BEEN FOUND AND MUST BE AVOIDED. DELETE IF NOT NEEDED.**

The letting date will be determined later as it depends on whether this project will be let with local funding or a successful award of a Bridge Improvement Grant for Replacement.

If there are any questions or comments please contact me at **NUMBER**.

Sincerely,

**NAME**  
**TITLE**

Attachment – Drainage Data Sheet & Contour Map for Existing Site & Plan/Profile for Selected Option

cc: **COUNTY/CITY – CONTACT NAME**  
**LGA – CONTACT NAME**

# Local Bridge Improvement Grant (BIG) Procedure

## EXAMPLE 3

### REPORT OF FOUNDATION INVESTIGATION

**PROJECT:** BRO 8048(03) Mellette County PCN 02DY

**LOCATION:** Structure No. 48-102-010, 18.9 miles North & 0.8 miles West of Cedar Butte over the White River.

#### **METHOD OF INVESTIGATION:**

All soundings are made according to the Standard South Dakota Subsurface Investigation Techniques and AASHTO Specifications. Auger holes are drilled with a 4-1/2 inch continuous flight auger. Penetration and Push Test holes are drilled with a 6-5/8 inch continuous hollow stem auger. Push core samples are obtained by hydraulically ramming a 2 foot long lined split spoon sampler into the soil to obtain 2 inch nominal diameter soil samples. Penetration tests are conducted by dropping a 140 pound hammer 30 inches to obtain 2 inch nominal diameter samples and to measure the resistance to penetration of the soil. Corings with the SDDOT drive rig are performed by using a California retractable plug sampler, which is driven with a 490 pound hammer. The drill stem is P.K. rod, which is 2-7/8 inch O.D., and 2 inch nominal diameter cores are obtained. All laboratory tests are performed in accordance with standard AASHTO or SDDOT laboratory procedures.

#### **RECOMMENDATIONS:**

##### Abutments:

##### I. Steel HP10 X 42 Piling

A. A LRFD maximum factored pile bearing resistance of 77 tons can be used for design.

B. The anticipated tip elevations are:

<u>Station</u>	<u>Elevation</u>
22+06	1910
25+27	1892

C. The nominal pile bearing resistance shall be 192 tons verified by the SDDOT's Modified ENR formula.

##### Bents:

##### I. Drilled Shafts

A. A LRFD maximum factored resistance value of 2,800 psf can be used for design below elevation 1912 ft. or maximum scour whichever is lower.

B. Permanent casings will be required to elevation 1915 ft.

C. The point of fixity within the bedrock can be assumed to be the elevation 1912 ft.

#### **DISCUSSION:**

The proposed structure location is underlain by brown sand-silt (alluvium) overlying brown silt-sand with gravel (alluvium). The alluvial sediments rest upon gray silt-clay (Pierre Shale). The D50 of the brown sand-silt, brown silt-sand with gravel, and gray silt-clay (Pierre Shale) can be assumed to be 0.06 mm, 1.0 mm, and 0.004 mm. The D95 of the brown sand-silt, brown silt-sand with gravel, and gray silt-clay (Pierre Shale) can be assumed to be 1.0 mm, 6.0 mm, and 0.06 mm.

Steel HP10X42 piling along with the anticipated tip elevations, are listed in the recommendations for use in the abutments. Drilled Shafts are listed in the recommendations for use at the bents.

The piling were evaluated for drivability and group effects at the LRFD Strength Limit State. Settlement of the substructure units and horizontal movement of the abutment piling were evaluated at the LRFD Service Limit State.

Drivability –



## Local Bridge Improvement Grant (BIG) Procedure

A drivability analysis was performed for the steel HP10X42 piling using the wave equation analysis program (GRLWEAP). A group of pile hammers that were evaluated and found to produce acceptable driving stresses is listed later in this report for inclusion in the plans.

### Pile Group Effects:

#### Axial Loading – Abutments

For a single row of piling, AASHTO requires the center-to-center pile spacing to be at least 30" or 2.5 times the width of the pile, whichever is greater. Therefore, for the steel HP10x42 piling at the abutment the center-to-center spacing shall be at least 30".

#### Settlement –

The steel pile tips will be founded in the Pierre Shale. Unconfined compression test results of the Pierre Shale exceed the proposed bridge loadings. Past experience for piling driven into hard shale soil bedrocks has shown little, if any, settlement has occurred. Therefore, 1/4 inch or less of total settlement can be used to design the substructure units.

#### Horizontal Movement –

AASHTO states that if the center-to-center spacing of the piling in the substructure unit is greater than 5 times the width of the pile then group effects can be ignored. Therefore, if the designed spacing is greater than 5 times the pile width a group efficiency factor of 1.0 can be used with no reduction in pile loading required. If this minimum pile spacing is not met a reduction factor will need to be calculated according to the AASHTO code.

Horizontal movement at the substructure units can be calculated using the following soil parameters:

Sand-silt (alluvium); phi angle = 24 degrees, cohesion = 50 psf, wet unit weight = 118 pcf  
Silt-sand with gravel (alluvium); phi angle = 32 degrees, cohesion = 0 psf, wet unit weight = 130 pcf  
Silt-clay (Pierre Shale); phi angle = 18 degrees, cohesion = 1,000 psf, wet unit weight = 130 pcf

For the drilled shafts, a LRFD maximum factored resistance value (skin friction) of 2,800 psf is recommended below elevation 1912 for the bents or maximum scour whichever is lower. The point of fixity within the bedrock can be assumed to be 1912 for the bents.

Each drilled shaft shall have a minimum of 3 access tubes for a shaft diameter of 3.0' and less. The number of access tubes needed shall be increased by 1 for each foot increase in shaft diameter above the 3.0'. The access tubes shall be furnished and installed according to the South Dakota Department of Transportation's 2004 Standard Specifications for Roads and Bridges. These access tubes shall be equally spaced in the shaft reinforcement prior to placing the reinforcement cage.

A representative of the [CONSULTING FIRM \(NAME AND NUMBER\)](#) shall be present during drilling operations to confirm the elevations provided in this report and to observe the placement of the drilled shafts. In addition to the notes below, contact the [CONSULTANT REPRESENTATIVE](#) for the most current drilled shaft construction notes to be included in the plans.

### **The following notes shall be placed in the plans:**

A drivability analysis was performed using the wave equation analysis program (GRLWEAP). The pile hammers listed below were evaluated and found to produce acceptable driving stresses. Pile hammers not listed will require evaluation and approval prior to use from the [CONSULTANT REPRESENTATIVE NAME AND PHONE NUMBER](#).

*Hammers need to be sized according to site specific soil parameters and structure design requirements. The following list of hammers is owned and readily available by contractors that do work in SD. Select and specify in the report which hammers are acceptable for use on individual projects.*

## Local Bridge Improvement Grant (BIG) Procedure

ICE 180	Delmag D12-42	FEC 1500	Delmag D16-32	Delmag D19-32
Delmag D19-42	MVE M-19	ICE 42S	MKT DE 42/35	APE D19-42
Delmag D25-32	Delmag D30-32	SPI D30	Delmag D46-32	



# Local Bridge Improvement Grant (BIG) Procedure

STATE OF	PROJECT	SHEET NO.	TOTAL SHEETS
S.D.			

Plotting Date: 03/26/2013

The Geotechnical Engineering Activity has on file all of the boring logs for this project. These logs and additional results of laboratory test, if any, are available for review at the Central Office in Pierre.

### LEGEND

- ⊕ Auger Test
- ⊙ Drive Test
- ∇ Water
- ⊖ Caved
- Penetration Test
- ▬ Sample Zone

Drive test are conducted by dropping a 490 pound hammer 30 inches to drive a 2 1/8 inch drill stem with attached retractable plug sampler for taking samples and to measure the resistance to penetration of the soil.

Auger holes are drilled with a 4 1/2 inch diameter continuous flight auger. Penetration and Push Test holes are drilled with a 6 3/8 inch diameter hollow stem auger. Push core samples are obtained by hydraulically ramming a 2 foot long lined split spoon sampler into the soil to obtain 2 inch nominal diameter soil samples.

### GROUND WATER ELEVATIONS

as of December 2012

T1	(Caved)	1931.3
T2	(Caved)	1910.9
T3	Dry	
T4		1929.7
T5		1926.9
T6		1928.9
T7		1930.2
T8		1929.1
T9		1930.0
T10		1929.3
T11	Dry	
T12		1929.8

### MEASURED SKIN FRICTION

	Elev	psf
T11	1924.0	2,193
T12	1907.3	1,214

BRD 8048(03) MELLETTE COUNTY PCN 02DY  
18.9 MILES N. AND 0.8 MILES W. OF CEDAR BUTTE  
SECTION 28 TOWNSHIP 45 W. RANGE 31 W.  
OVER WHITE RIVER  
STR. NO. 48-102-010

### SITE PLAN & SUBSURFACE PROFILE

DESIGNED BY	DRAWN BY	CHECKED BY	APPROVED
	NN	JW	

BRIDGE ENGINEER

Pierre Shale is a marine shale with a textural classification that varies from silt-clay to clay-silt. Color varies from buff gray to black. The formation may contain concretions that are normally thin but occasionally are massive. These zones may be considered hard and dense. Thin zones may be present that are cemented resulting in claystone or siltstone seams. Bentonite zones may be encountered but are normally less than one half inch thick. Nonweathered Pierre Shale is considered to be "Soft Rock".

Hole Number	Station	Depth	Soil Color	Classification	Strength (Q <sub>v</sub> )	Dry Density	Wet Density	Moisture	Pass No. 10	Pass No. 40	Pass No. 200	Sand Content	Silt Content	Clay Content
T2	21493	5.8	Brown	Sand-Clay	85.3	pcf	115.3	17.0	95.5	51.1	55.1	44.8	45.1	10.0
T3	23492	5.7	Brown	Silt	81.7	pcf	107.0	12.3	95.9	51.1	55.1	44.8	45.1	10.0
T4	24492	17.0	Brown	Sand	97.8	pcf	127.0	9.4	96.2	57.4	56.9	36.3	9.9	2.0
T5	24497	23.8	Gray	Clay	55.490	pcf	136.6	16.9	95.8	55.7	56.9	2.8	41.1	55.9
T6	24499	37.8	Gray	Clay	49.749	pcf	112.5	18.5	98.8	59.8	59.5	0.3	39.4	59.8

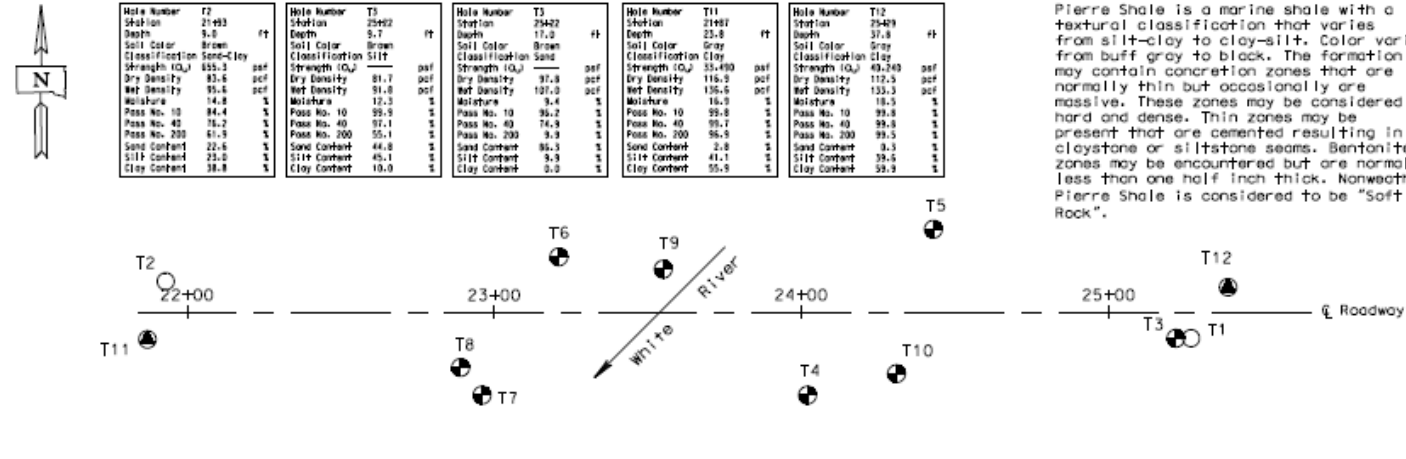

\* Values represent uncorrected "N" values from Penetration Test.

Sample Zone 48 Blows Per Foot

Bore holes on profile are moved slightly for clarity

Penetration tests are conducted by dropping a 140 pound hammer 30 inches to obtain 2 inch nominal diameter samples and to measure the resistance to penetration of the soil.

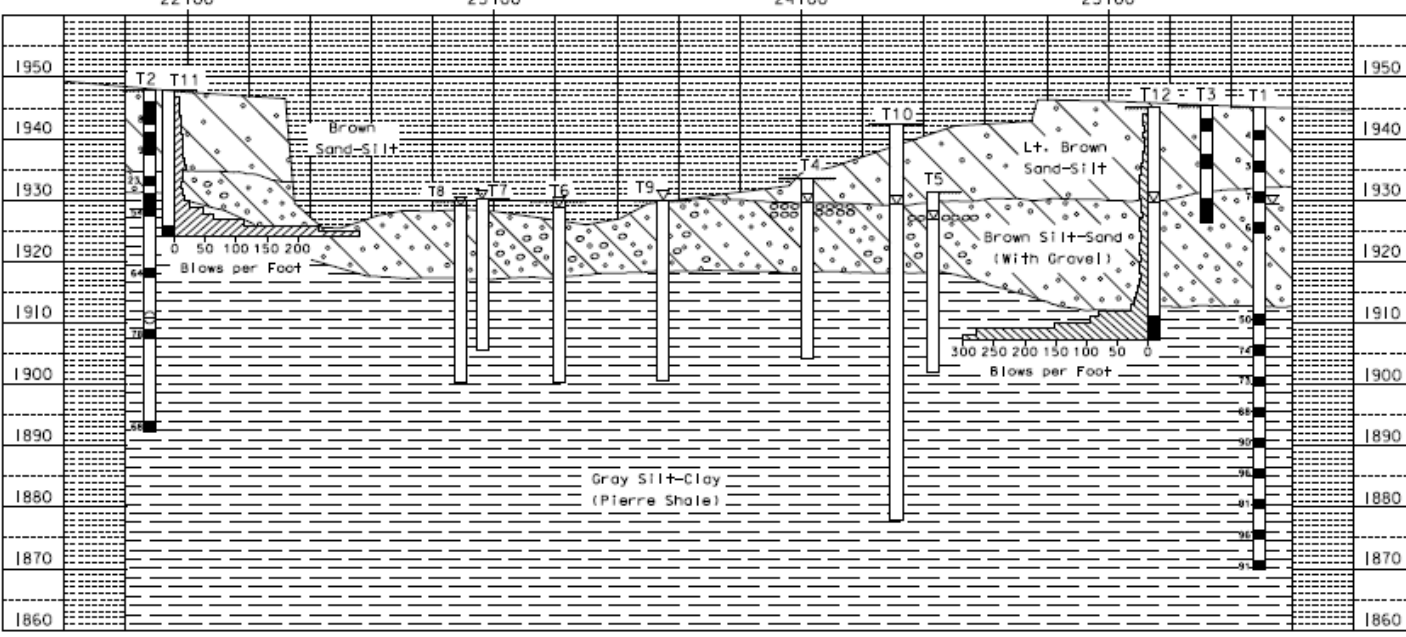

PLOT SCALE - 1/2" = 1'-0"

PLOTTER FROM - TEMPL 0174

FILE - ...SUBSURFACE PROFILE.DWG.DGN

# Local Bridge Improvement Grant (BIG) Procedure

## RECOMMENDATIONS

## EXAMPLE 4

**Re:** BRO 8027(29), Gregory County, PCN 00QR  
Str. No. 27-030-081, located 2.0 West & 0.1 South of the Jct of SD44/SD47  
RCBC Undercut Recommendation

Soils maps of the area indicate the soils at the location of the proposed structure have the following characteristics.

### Station 16+86 (Str. No. 27-030-081)

CLASSIFICATION: A-7  
Clay & Silty Clay  
AVERAGE LIQUID LIMIT: 66  
SHRINK-SWELL POTENTIAL: High to Very High  
FROST ACTION POTENTIAL: Low  
CORROSIVITY: High for steel, Low to Moderate for concrete

### **RECOMMENDATIONS:**

Provide 24 inches of undercut and backfill.

### **DISCUSSION:**

The project consists of replacing an existing single span 22' steel stringer bridge with a 2 barrel 13' x 6' cast-in-place RCBC. The proposed box culvert will be in the same location as the existing bridge location. The existing surfacing on the road is gravel and will be resurfaced with gravel upon completion. Minimal grading at the proposed box culvert location is anticipated, therefore, the material shall be compacted using the Ordinary Compaction Method.

A subsurface investigation was conducted for the proposed RCBC. The subsurface investigation consisted of placing a boring near both the proposed inlet and outlet ends of the structure and logging the material to 3 feet below the flow line. Samples were collected from below the flow line for soils classification. A dynamic cone penetrometer was used at both the inlet and outlet ends to identify the change in relative density of the subsurface material below flow line.

Subsurface soils at the proposed site consist of brown silt-clay to 3' below the existing flow line.

The 2' undercut depth is recommended to remove the low strength soils with high shrink-swell potential from below the box culvert.

### **The following paragraphs shall be placed in the plans:**

Compaction of earth embankment and box culvert backfill material shall be governed by the Ordinary Compaction Method.

Any questions about the recommendations or the subsurface conditions can be directed to the [CONSULTANT CONTACT NAME AND PHONE NUMBER](#).

# Local Bridge Improvement Grant (BIG) Procedure

## HYDRAULIC DATA SHEET

County \_\_\_\_\_ Project No. \_\_\_\_\_ PCN \_\_\_\_\_ Sec. \_\_\_\_\_ Township \_\_\_\_\_ Range \_\_\_\_\_  
 Station 23+41.8 Over North Branch of CREEK Drainage Area 52.3 Sq. Mi. Direction of Flow East  
 Preliminary X Final \_\_\_\_\_ Q-Design Yr. Frequency 25-year Observed H.W. Elev 1283.1  
 STRUCTURE NO. ##-###-### LOCATION LOCATION

Cross Section	Qd. cfs	W.W. Area sq.ft.	V fps	So. ft./ft.	Bottom		H.W. ft.	dn ft.	C.L. FL Elev.	D.H.W. Elev.		Ch Ch	Degree Skew
					Structure	Ch.				Culv. Inlet	Bridge		
Trapezoid 2:1 S:S	1979	335	5.9	.0018		Natural		8.1	1273.18*		1281.8	No**	0°
Rectangle II	1979	330	6.0	.0018	4B=40'		8.7	8.3	1273.18*	1281.9		No**	0°
Rectangle III	1979	360	5.5	.0018	4B=44'		8.7	8.3	1273.18*	1281.9		No**	0°

Type: I. Berm Type Bridge II. RCBC w/30° Flared Wing walls at Inlet and 0° Flared at Outlet III. Precast CBC with 0° Flared Wing walls at Inlet and Outlet

Size: I. 82.0 ft. (single span with 45 M Section) II. 4-10'x10' (effective opening 4-10'x9') III. 4-11'x10' (effective opening 4-11'x9')

Proposed Location I. Center at Sta. 23+26, berm toes located at Sta. 23+12± (elev. 1274.0) & Sta. 23+40 ± (Elev. 1274.0) II. Center at Sta. 23+37 III. Center at Sta. 23+37

Notes or Remarks: Discharges were obtained from Methods Outlined in Water Resources Report 98-4055 for ungaged sites near a gaging station on the same stream. Stream gage # 06478260 for years of record from 1956-1978. Q<sub>2</sub> = 91 cfs; Q<sub>25</sub> = 1979 cfs; Q<sub>100</sub> = 4997 cfs; Q<sub>500</sub> = 11,811 cfs. Structure width and flowline elevation for the box culvert options meet the criteria called for in the US Army Corp. of Engineers 2012 Regional Conditions for aquatic organisms.

INPLACE CONDITIONS: Q<sub>2</sub> Elev. = 1275.0, HW<sub>25</sub> = 1281.8, HW<sub>100</sub> = 1286.9 \*\*\* Overtop Freq. = Q<sub>85</sub> = 4500 cfs, V<sub>max</sub> = V<sub>85</sub> = 9.1 fps  
PROPOSED CONDITIONS: I. Q<sub>2</sub> Elev. = 1274.9, V<sub>2</sub> = 2.8 fps, HW<sub>100</sub> = 1284.8, \*\*\*Overtop Freq. = Q<sub>274</sub> = 8000 cfs, V<sub>max</sub> = V<sub>100</sub> = 11.7 fps  
II. Q<sub>2</sub> Elev. = 1274.4, (Q<sub>2</sub> Depth = 1.1 ft. and V<sub>2</sub> = 2.1 fps at culvert outlet), HW<sub>100</sub> = 1287.2, \*\*\*Overtop Freq. = Q<sub>185</sub> = 6450 cfs, V<sub>max</sub> = V<sub>100</sub> = 13.9 fps  
III. Q<sub>2</sub> Elev. = 1274.4, (Q<sub>2</sub> Depth = 1.1 ft. and V<sub>2</sub> = 1.9 fps at culvert outlet), HW<sub>100</sub> = 1287.2, \*\*\*Overtop Freq. = Q<sub>180</sub> = 6400 cfs, V<sub>max</sub> = V<sub>100</sub> = 12.6 fps

Additional Remarks: \*Elevation of the Stream flowline at the centerline of the proposed roadway. The box culvert flowline has been lowered 12" below stream flowline and this embedded depth is assumed to not convey any water.  
\*\*Minor channel shaping will be required at channel inlet and outlet.  
\*\*\*The existing roadway overtops at Elev. 1286.23 near Sta. 23+75 and the proposed gradeline overtops at Elev. 1290.8 at Sta. 23+50.  
Δ Hutchinson County is participating in NFIP.  
◆ The area is not mapped and is considered NSFHA (No Special Flood Hazard Area)

PRELIMINARY X FINAL SCOUR RECOMMENDATIONS: I. Riprap will be required on both bridge berms. Foundation Report has not been received. Contraction Scour for proposed bridge is estimated at 6.0 ft. for the 100 year event. Scour estimate is based on assumed D<sub>50</sub> = .2mm. II & III. Provide 33 in. thick Class B riprap on newly graded 2:1 bank slopes from elev. 1280.0 down to culvert Flowline and across channel at outlet. Extend riprap 18.0 ft. downstream of wings. Provide Type B drainage fabric beneath all riprap. Natural Stream bed material will not need to be placed over riprap and culvert invert.

Vertical Datum Used: NAVD 88: X NGVD 29: \_\_\_\_\_ Unknown: \_\_\_\_\_  
 Topeka Shiner Stream: Yes X No \_\_\_\_\_  
 Community Participating in NFIP Program: Yes X Δ No \_\_\_\_\_  
 Site in Identified NFIP Floodplain: Yes \_\_\_\_\_ No X ◆

Prepared by: Signature  
 Date: DATE  
 Checked by: Signature  
 Date: DATE

# PRELIMINARY HYDRAULIC DATA LAYOUT

To Define the Minimum Channel Configuration at Bridge

Project BR - #### (00)  
 County \_\_\_\_\_  
 PCN \_\_\_\_\_

Station 23+26  
 Skew 0°  
 Date Prepared DATE

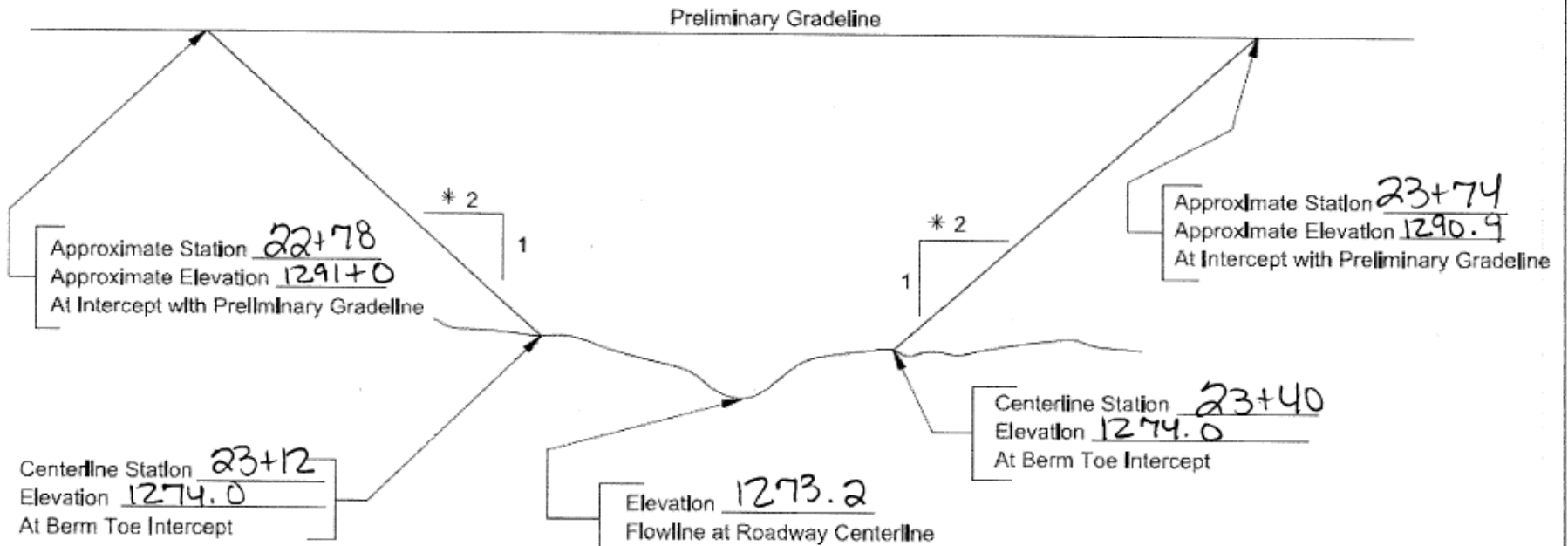

\* Berm slope perpendicular to channel centerline. If bridge is skewed, berm slope must be adjusted to meet skew.

This idealized drawing is not to scale.  
 See project roadway profile for more details.

Local Bridge Improvement Grant (BIG) Procedure

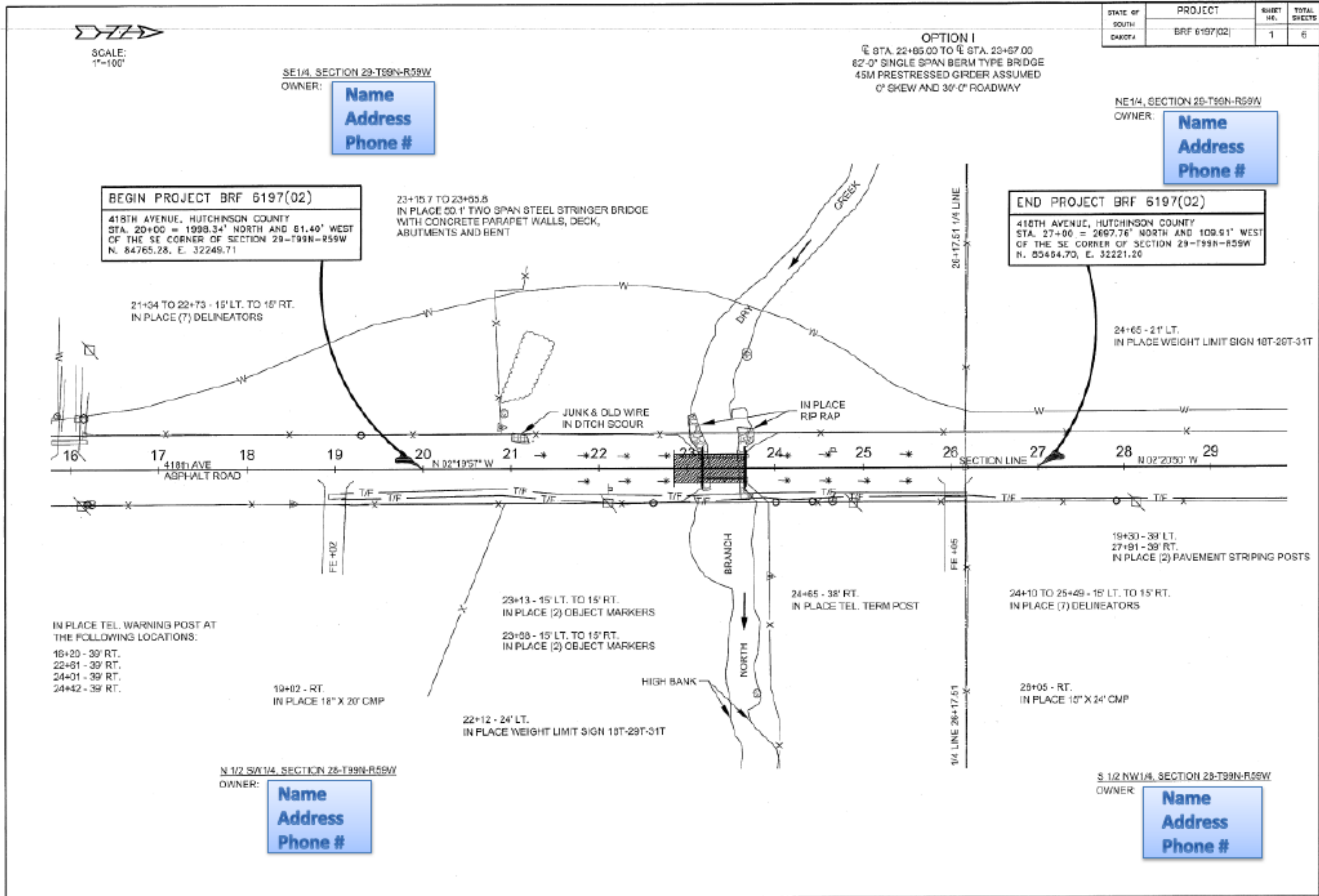



# Local Bridge Improvement Grant (BIG) Procedure

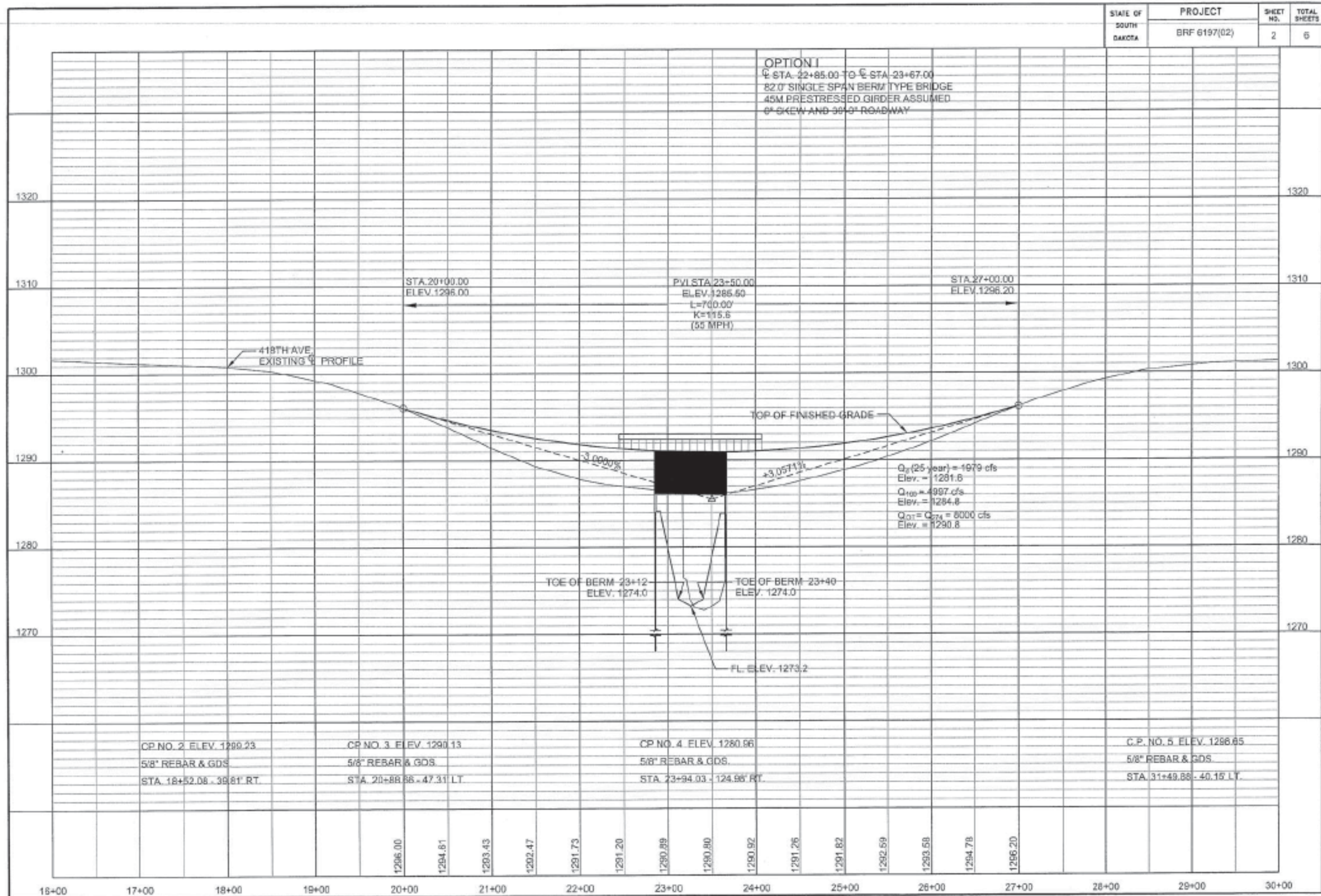

Local Bridge Improvement Grant (BIG) Procedure

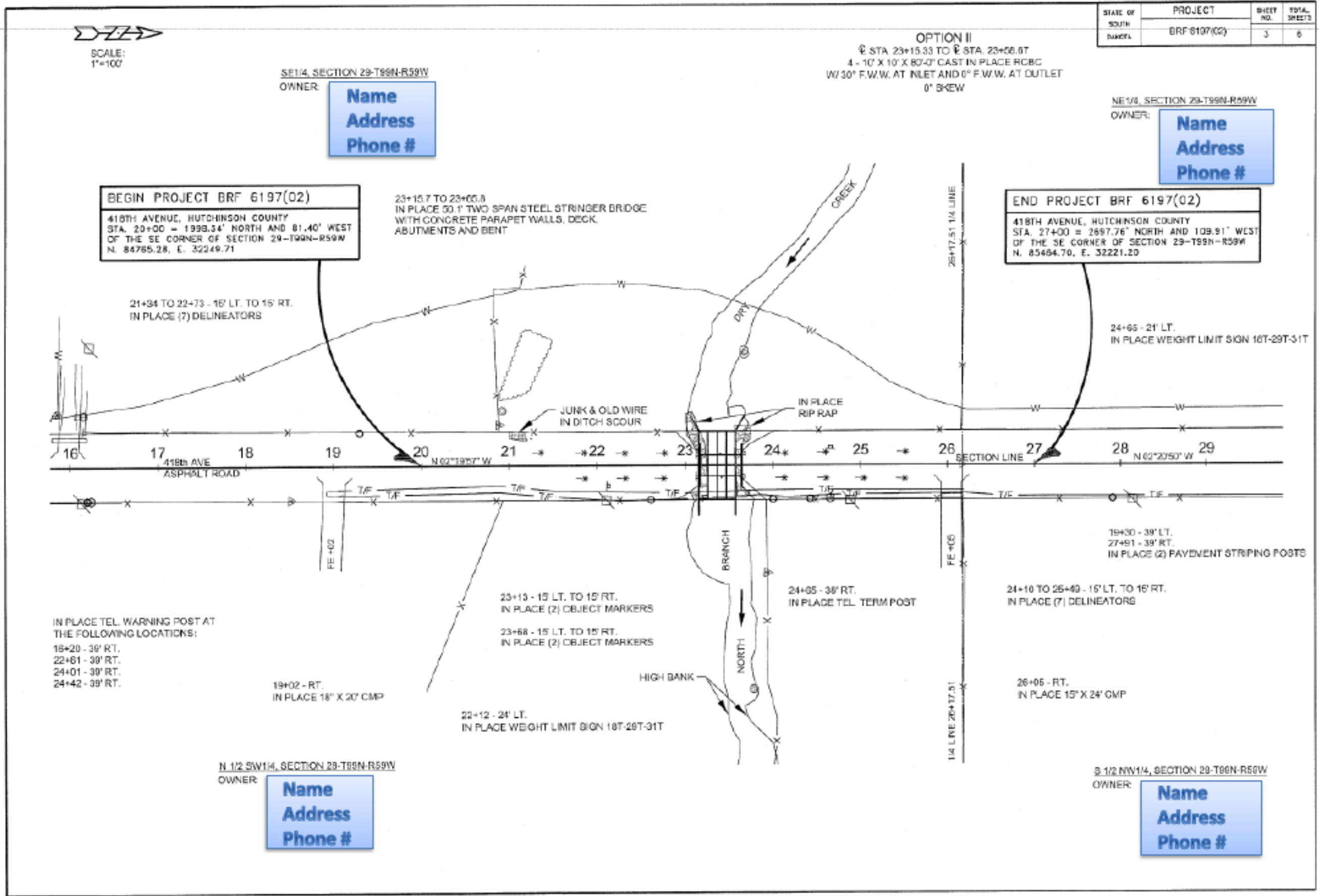



Local Bridge Improvement Grant (BIG) Procedure

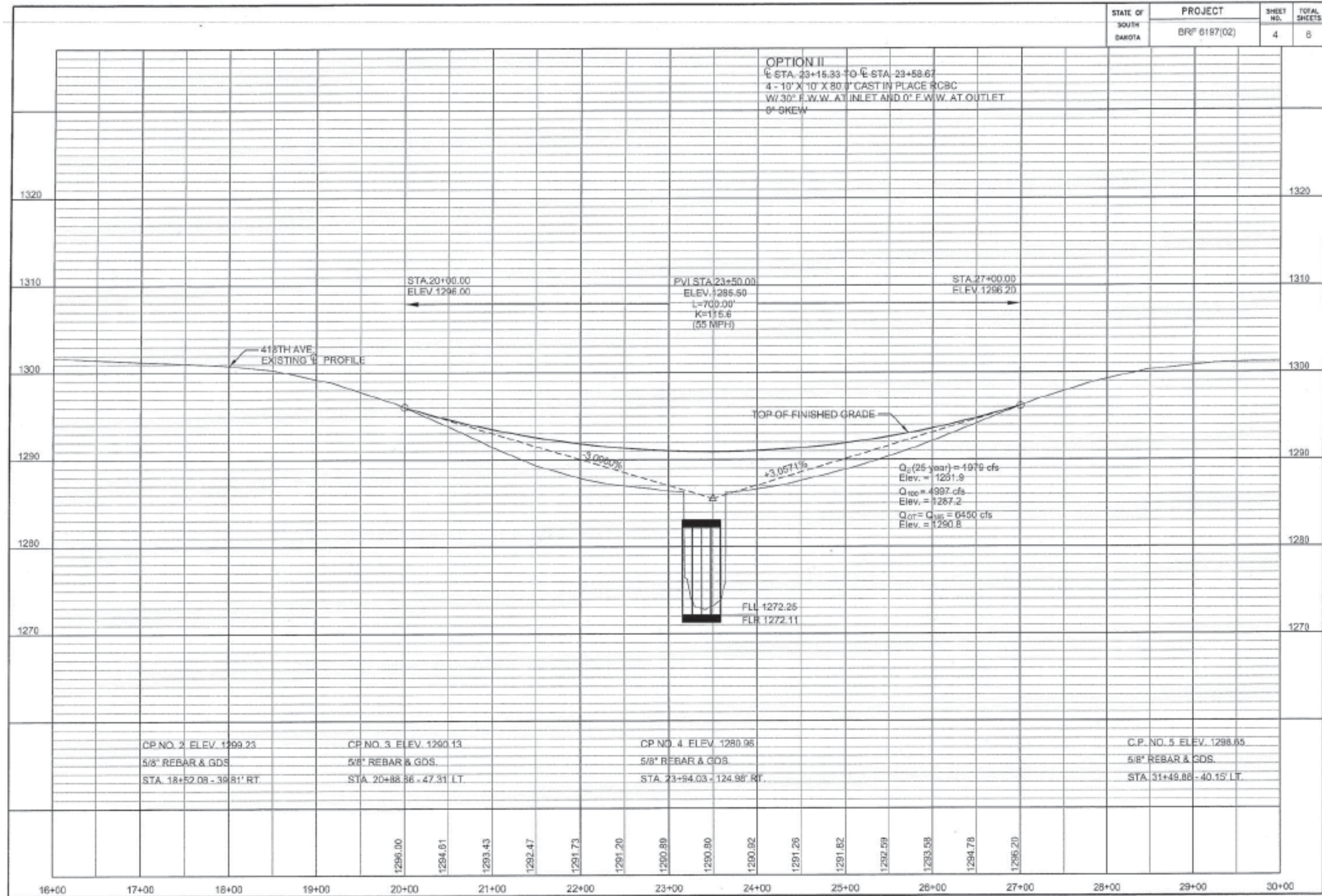



Local Bridge Improvement Grant (BIG) Procedure

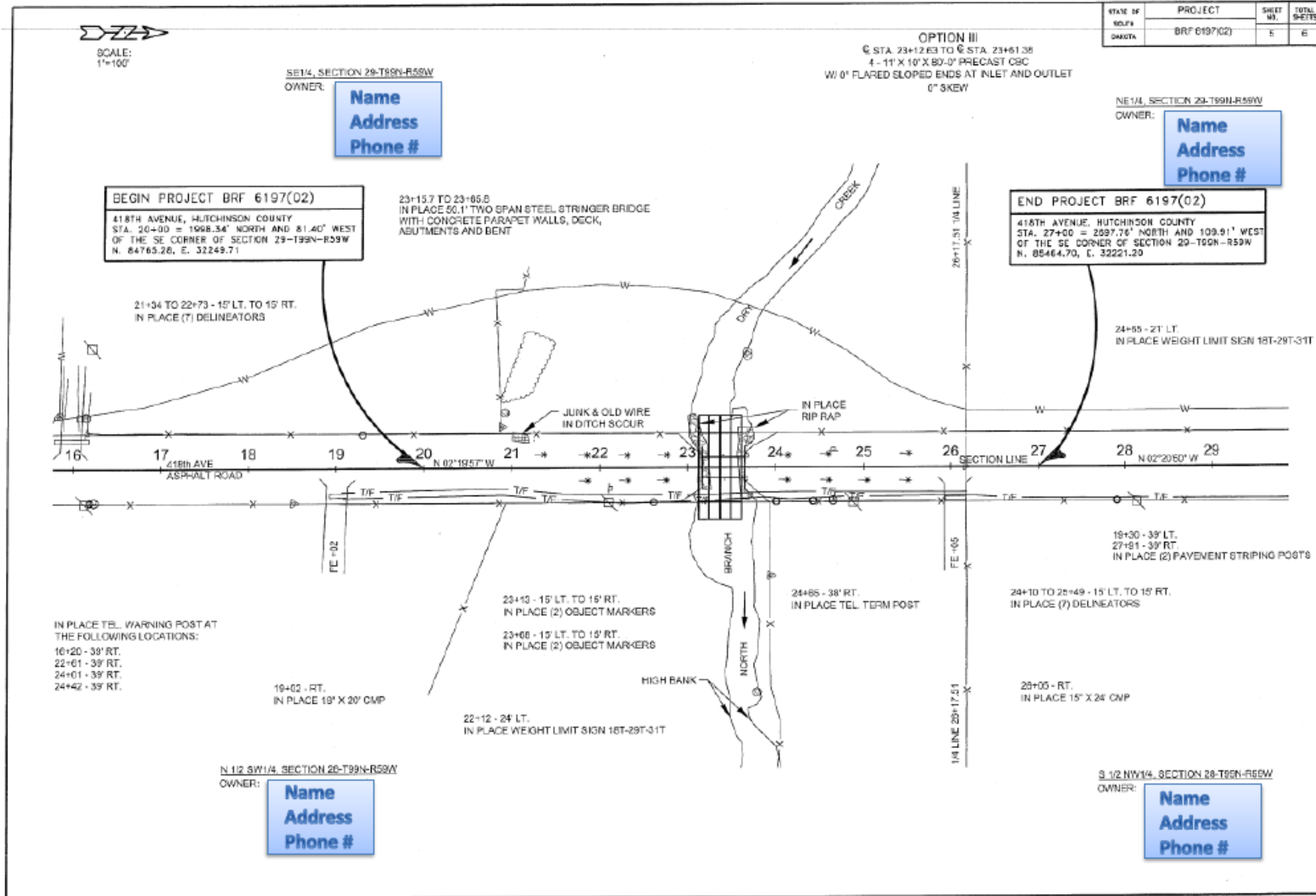

# Local Bridge Improvement Grant (BIG) Procedure

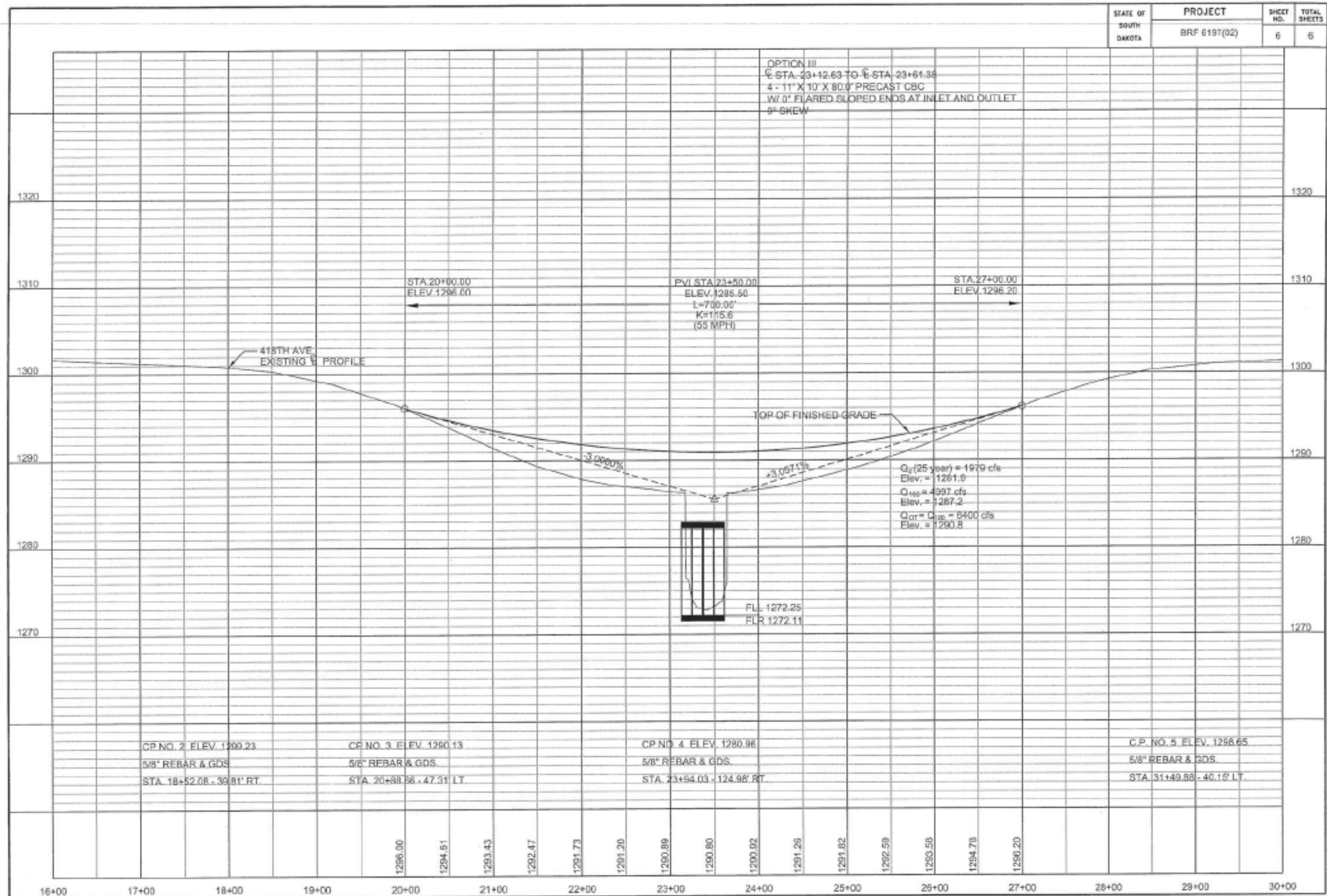









## Local Bridge Improvement Grant (BIG) Procedure

Photo Documentation and Record Search for Hutchinson County Structure No. 34-140-096

The offices and individuals contacted include:

Hutchinson County Assessor	Tony Dewald	No Information
Hutchinson County Auditor	Diane Murtha	No Information
Hutchinson County Highway Superintendent	Joel Baumiller	Inspections Reports (We already had)
Hutchinson County Register of Deeds	Unknown	No Information
Hutchinson County Treasurer	Tamara Miller	No Information
Heritage Hall Museum (in Freeman)	Kelsey Ortman	No Information
Heritage Hall Archives (in Freeman)	Kelsey Ortman	No Information

The Hutchinson County Assessor, Tony Dewald, was contacted on May 25<sup>th</sup>, 2015 by Diane Murtha. Murtha reported that Dewald had not found any information regarding the structure.

The Hutchinson County Auditor, Diane Murtha, was contacted on May 6<sup>th</sup>, 2015 by email. Murtha noted that she had not found any information regarding the structure. She also noted that she had talked to the Department of Equalization and the Register of Deeds, neither of which could provide information about the structure.

The Hutchinson County Highway Superintendent, Joel Baumiller, was contacted on May 6<sup>th</sup>, 2015 by email. Baumiller then responded by phone that same day and was not able to provide information other than the inspection reports that we ( **FIRM** ) already had. The reports provided the approximated date of completion of the structure (1935) as well as information specific to the construction and condition of the structure. The inspection report is attached.

The Hutchinson County Register of Deeds, Unknown, was contacted on May 25<sup>th</sup>, 2015 by Diane Murtha. Murtha reported that the Register of Deeds had not found any information regarding the structure.

The Hutchinson County Treasurer, Tamara Miller, was contacted on May 6<sup>th</sup>, 2015 by email. Miller has not yet responded.

The Heritage Hall Museum and Heritage Hall Archives, run by Kelsey Ortman, were contacted on May 25<sup>th</sup>, 2015 by email. Ortman reported that she had not found any information regarding the structure.

The State Historic Preservation Office's CRGRID was also used to find any historic survey's conducted on the structure. It revealed the structure was Surveyed in 2004. The survey summary and report are attached.

# Local Bridge Improvement Grant (BIG) Procedure

SOUTH DAKOTA STATE HISTORIC PRESERVATION OFFICE

RECORD SEARCH SUMMARY - BRIDGE

04-16-2015



---

<u>SHPO ID</u>	<u>Bridge Name</u>	<u>UTM Zone</u>	<u>UTM Easting</u>	<u>UTM Northing</u>	<u>Date Built</u>
HT00001571	34-140-096	14	594245.0000	4801719.0000	1935
<u>Survey Date</u>	<u>Street</u>	<u>City</u>	<u>County</u>	<u>Location Description</u>	<u>TWP</u>
6/25/2004 12:00:00 AM	418 AVE	Parkston	HT	8E 2.6S PARKSTON	99N
<u>Rng</u>	<u>Sec</u>	<u>Quarter1</u>	<u>Quarter2</u>	<u>DOE</u>	<u>Nomination Status</u>
59W	28	NW	SW	NR Eligible	

---

Local Bridge Improvement Grant (BIG) Procedure

SOUTH DAKOTA STATE HISTORIC PRESERVATION OFFICE  
HISTORIC SITES SURVEY BRIDGE FORM 04-16-2015



**SHPOID** HT00001571  
**SiteID** 48635  
**BridgID** 2211

**SITE INFORMATION**

**\*Survey Date:** 6/25/2004 12:00:00 AM  
**\*Surveyor:** Jennie Goff / Renewable Technologies, Inc.  
**\*Property Address:** 418 AVE  
**\*County:** HT  
**\*City:** Parkston  
**\*Quarter1:** NW  
**\*Quarter2:** SW  
**\*Township:** 99N  
**\*Range:** 59W  
**\*Section:** 28  
**Acres:**  
**Quadname:** Parkston SE (1968)  
**Legal Description:** North Branch of Dry Creek

**Location Description:** 8E 2.6S PARKSTON

**Owner Code1:**  
**Owner Code2:**  
**Owner Code3:**  
**Owner Name:**  
**Owner Address:**  
**Owner City:**  
**Owner State:**  
**Owner Zip:**

**HISTORIC SIGNIFICANCE**

**\*DOE:** NR Eligible  
**\*DOE Date:** 6/25/2004 12:00:00 AM  
**Nomination Status:**  
**Listed Date:**  
**Ref Num:**  
**Period:**  
**Category:**  
**Historic District Rating:**  
**Register Name:** 34-140-096  
**Multiple Property Name:**  
**SignificanceLevel1:**  
**SignificanceLevel2:**  
**NR Criteria 1:**  
**NR Criteria 2:**  
**NR Criteria 3:** C  
**NR Criteria 4:**

**Significance Notes :** This bridge retains historic integrity, although it has minor condition problems due to collision damage. It is a good example of pre-World War II steel stringer bridge construction in South Dakota, reflecting both the history and technology of such projects. Bridge 34-140-096 is eligible for listing in the National Register of Historic Places under criterion C, as an example of the steel stringer type for the Depression period.

# Local Bridge Improvement Grant (BIG) Procedure

SOUTH DAKOTA STATE HISTORIC PRESERVATION OFFICE  
HISTORIC SITES SURVEY BRIDGE FORM 04-16-2015



## BRIDGE DETAILS

**\*Bridge Name:** 34-140-096

**Other Name:**

**\*Date Built:** 1935

**Significant Person:**

**Structural System:**

**Type:** Stringer

**Length:** 50

**Style:** No Style

**Number Of Spans:** 2

**Materials:** Steel

**ApproachSpanType:** N/A

**Occupied:**

**\*UTM Zone:** 14

**Accessible:**

**\*UTM Easting:** 594245.0000

**\*UTM Northing:** 4801719.0000

**Restricted:** N

**Altered/Moved Notes:**

**Physical Notes:** This structure is a two span steel stringer bridge that carries 418th Avenue (paved) over the North Branch of Dry Creek. It is located in rural Hutchinson County about 8.5 miles southeast of Parkston in a region of cultivated fields and rolling grassland. The superstructure consists of 12 steel I-beam stringers supporting a concrete deck. Precast concrete balustrade rails with elliptical openings flank the bridge. A short portion of the south end of the west rail has been damaged by a vehicle collision. Abutments, backwalls, and wingwalls are solid concrete. The intermediate pier is open concrete, consisting of two rectangular (in cross section) vertical posts with a solid, cantilevered cap. Recessed panels bearing the date "1935" are found on the insides of the curbs. Other than the moderate rail damage, the structure remains essentially as-built.

**Link to National Register Nomination:**

**No National Register Nomination Available**



**Appendix B – Structure Design Work Order Requirements**

# Local Bridge Improvement Grant (BIG) Procedure

## Bridge Improvement Grant Work Order Requirements for Structure Design

### SCOPE OF SERVICES TEMPLATE – Design

#### Category-Specific Technical Requirements & Provisions, from the Current SDDOT Consultant Retainer, Shall Be Applied

1. **Preparation of sketches of the structure as selected during the TS&L.** The Consultant shall submit general drawing sheets, a riprap layout, and plan/profile of the selected option to the Local Government Assistance Office for review at the START OF DESIGN. (Not applicable for Bid Ready grants.)
2. **Survey and plans for the above referenced project as described in the TS&L letter and Final Hydraulics Data Sheet, design calculations, independent design check, and load ratings.** Review plans (100% complete) are to be submitted in PDF format. Specifications shall follow the most current edition of the Standard Specification for Roads and Bridges. South Dakota Department of Transportation Bid Items, Standard plates and plan notes, from the SDDOT website, must be used in development of the plans.

The consultant shall provide design calculations, independent check, and load ratings for the structure as set forth in the Master Retainer Contract. The Consultant is wholly responsible for the accuracy and safe keeping of the design calculations and the independent design check.

3. **Incorporation into the plans of any changes that may be requested in the SDDOT plan review comments or provide written explanation for items not changes.**
4. **Review of shop fabrication drawings as may be required and submittal of the approved shop drawings to the Consultant.** This item is to be completed within two (2) weeks of receipt of shop or fabrication drawings from the contractor and shall be noted accordingly in the plans.
7. **Provide a Construction Management Plan based on SDDOT Materials Manual.** This document must be reviewed by the SDDOT prior to the notice to proceed being issued to the contractor. See **Appendix D** for requirements.

Please refer to the checklist in **Attachment #1** for the items required to be submitted to the Local Government Assistance Office.

**NOTE: Foundation investigation will need to be included for projects that did not have this work included in the preliminary engineering. See BIG Procedures for direction on whether DOT Foundations or a subconsultant on the Retainer for Geotech Investigation will do this work. See also Appendix C, Examples #1 and #2 for requirements.**

Local Bridge Improvement Grant (BIG) Procedure

**Attachment #1**  
**Local Government Assistance**  
**Checklist for Structure Design Work Order**

These items must be submitted to DOT/Local Government Assistance.  
If any of these items are missing, the full packet will be returned for completion and resubmission to this office.

Project Number \_\_\_\_\_ County \_\_\_\_\_ PCN \_\_\_\_\_

---

To be submitted at the START OF DESIGN

- Plan/profile, general drawing sketches, and riprap layout as selected during the TS&L

---

To be submitted well in advance of anticipated letting

- Review Plans (100% complete & ready for review) in PDF Format
- Design calculations, independent design check, and load ratings

---

To be submitted after SDDOT plan review is complete

- All Plan Review Comments must be Addressed and Documented
- Final Plans – Electronic PDF file of the engineered, stamped set of plans
- Construction Management Plan

**Appendix C – Structure Preservation or Rehabilitation Work Order Requirements**

# Local Bridge Improvement Grant (BIG) Procedure

## Bridge Improvement Grant

### Work Order Requirements for Structure Preservation or Rehabilitation

**Note:** Not all preservation or rehabilitation work will require hydraulic analysis or foundation investigation. For this reason, several of the related items below have been marked “**if needed.**” If the Subject project does not require hydraulic analysis and/or foundation investigation, simply do not include these items in the breakdown of estimated costs.

#### SCOPE OF SERVICES TEMPLATE – Structure Preservation or Rehabilitation

##### Category-Specific Technical Requirements & Provisions, from the Current SDDOT Consultant Retainer, Shall Be Applied

1. **Field survey for completion of the Drainage Data Sheet and Contour Map.** The information required for placement on these sheets is listed below. An example is attached containing the required information.
  - Stationing from south to north or west to east.
  - Beginning and ending stations of the current structure.
  - Proposed and in-place gradelines.
  - Stream profile. (Including a table of stations and elevations for each shot taken.)
  - Sea level datum is required. Stations, elevations, and offsets from and descriptions of permanent objects will be required for project benchmarks. (The High Accuracy Reference Network (HARN) map and the County Bench Mark map for the State of South Dakota can be found at the following web site – <https://dot.sd.gov/doing-business/engineering/design-services/surveyors>)
  - Include an electronic file containing the plan/profile of the in-place gradeline at the structure.
  - Landowners with their addresses, phone numbers, and location of property.
  - Utilities with their addresses, phone numbers, and locations along the project.
  
2. **Field survey as necessary for preparation of construction plans.** Required information is listed below.
  - Establishment of transit points, land ties and benchmarks as well as cross sections and topography. (Stations, elevations, and offsets from permanent objects will be required for project benchmarks.)
  - Project limits as established by consultation with the County Highway Superintendent / City Engineer.
  - Additional legal survey as required for preparation of right-of-way plats.
  - The geometrics of horizontal and vertical alignment in accordance with the Local Roads Plan design standards.
  - Survey notes are to be retained on file with the Consultant for subsequent use in the preparation of construction plans and are to be available to the County/City upon request.
  
3. **(If needed.) Preliminary Hydraulic Data Sheet, Plan/Profile Sketches (Preliminary Hydraulic Layouts) and gradelines, Electronic Copy of the Hydraulic Model, Draft Hydraulic Design Report in accordance with the newest version of the South Dakota Drainage Manual, and cost estimates for existing and all proposed structure alternatives. (More than one feasible alternative is required. This includes options on different alignments if applicable. The options need to be acceptable to the owner’s future needs and maintenance capabilities. If there is only one type of structure that can reasonably be constructed at a site, simply provide an explanation instead of alternatives.)** The newest version of the South Dakota Drainage Manual is available at the following location: <https://dot.sd.gov/doing-business/engineering/design-services/forms-manuals>. Guidance and examples can be found in Chapter 6 of the manual. **The current preliminary hydraulic data sheet to be used can be found in the folder under “000 LGA General Info and Docs” located on the Consultant’s LGA SFTP site.** Directions for filling out the form can be found at the same location. All items will be submitted to the Local Government Assistance Office for distribution to SDDOT personnel for review for compliance with minimum required State and Federal standards. Necessary revisions shall be provided in writing by the SDDOT and shall be forwarded to the Consultant by the Local Government Assistance (LGA) Office. Necessary revisions shall be completed by the consultant and the Revised Draft Hydraulic Design Report submitted within 2 weeks of receipt of revisions from LGA. The Consultant is wholly responsible for the accuracy of the design calculations and the independent check design calculations.

## Local Bridge Improvement Grant (BIG) Procedure

4. **(If needed.) Conduct TS&L inspection, assistance in the selection of the type of preservation or rehabilitation, and preparation of TS&L summary letter.** The county or city (owner) shall be in attendance and advance notice given the Local Government Assistance Office so if time allows, a staff member can attend.
5. **(If needed.) Report of Foundation Investigation.** Conduct field investigation and provide design recommendations according to AASHTO LRFD Bridge Design Specifications Section 10. Report shall include boring information, lab results, and design recommendations. See **Examples #1 and #2, following the attachments**, for reports that are typically developed by SDDOT Geotechnical Engineering Activity.
6. **(If needed.) For Structure Chosen at TS&L: Final Hydraulic Design Report, Final Hydraulic Data Sheet (use the current data sheet found in the folder “000 LGA General Info and Docs” located on the LGA SFTP site,) Hydraulic model with existing and proposed conditions, and if the structure selected is a bridge, Scour Memo summarizing hydraulic scour calculation, Scour Calculation, and Berm Slope Protection Recommendations (if applicable.)**
7. **Survey and plans for the above referenced project as described in the application or TS&L letter (if applicable) and Final Hydraulics Data Sheet, design calculations, independent design check, and load ratings.** Review plans (100% complete) are to be submitted in PDF format. Specifications shall follow the most current edition of the Standard Specification for Roads and Bridges. South Dakota Department of Transportation Bid Items, Standard plates and plan notes, from the SDDOT website, must be used in development of the plans.  
  
If applicable to the type of rehabilitation, the consultant shall provide design calculations, independent check, and load ratings for the structure as set forth in the Master Retainer Contract. The Consultant is wholly responsible for the accuracy and safe keeping of the design calculations and the independent design check.
8. **Incorporation into the plans of any changes that may be requested in the SDDOT plan review comments or provide written explanation for items not changes.**
9. **Review of shop fabrication drawings as may be required and submittal of the approved shop drawings to the Consultant.** This item is to be completed within two (2) weeks of receipt of shop or fabrication drawings from the contractor and shall be noted accordingly in the plans.
10. **Provide Quality Assurance / Quality Control Testing Plan based on SDDOT Materials Manual.** This document must be reviewed by the SDDOT prior to the notice to proceed being issued to the contractor. See **Appendix D** for requirements.

Please refer to the checklist in **Attachment #1** for the TS&L Packet of items that shall be submitted to the Local Government Assistance Office.

# Local Bridge Improvement Grant (BIG) Procedure

## Attachment #1 Bridge Improvement Grant Checklist for Structure Preservation or Rehabilitation Work Order

These items must be submitted to DOT/Local Government Assistance.  
If any of these items are missing, the full packet will be returned for completion and resubmission to this office.

Project Number \_\_\_\_\_ County \_\_\_\_\_ PCN \_\_\_\_\_  
**CROSS OFF ANY NON-APPLICABLE ITEMS**

- Survey Sheets and Contour Map including the following information:
  - Stationing from south to north or west to east
  - Beginning and ending stations of the existing structure
  - Beginning and ending stations of proposed structures
  - Proposed and existing gradelines
  - Stream profile and cross sections (Downstream to upstream direction including a table showing stations and elevations for each shot taken)
  - Elevation and location of buildings and other structures
  - Survey information using sea level datum and showing station, elevation, offset, and physical description of each project benchmark
  - Landowner names, addresses, phone numbers, and legal descriptions of their property
  - Utility names, addresses, phone numbers, and locations along the project
  
- Preliminary Hydraulic Data Sheet (use current data sheet found in the folder “000 LGA General Info and Docs” located on the LGA SFTP site) including the following information:
  - Calculated flows
  - Inplace conditions (Ordinary High Water Elevation, HW<sub>100</sub>, Vmax, OTfr)
  - Proposed conditions for each option (HW<sub>2</sub>, HW<sub>25</sub>, HW<sub>100</sub>, Vmax Qot, OTfr, ELOvertop)
  - Ordinary High Water Elevation Shown on Cross-Sections (vegetation elevation on stream banks – approx. 2-year flow)
  - Observed High Water Elevation (identifiable high water mark)
  
- Electronic copy of Hydraulic Model of existing and proposed conditions
  
- Plan and profile sketches (preliminary hydraulic layout sheets) for the existing structure and proposed gradelines for each option (More than one feasible alternative is required. This includes options on different alignments if applicable. The options need to be acceptable to the owner’s future needs and maintenance capabilities. If there is only one type of structure that can reasonably be constructed at a site, simply provide an explanation instead of alternatives.)
  
- Cost Estimates (including design and construction engineering and construction costs for each option.)

# Local Bridge Improvement Grant (BIG) Procedure

Revised Draft Hydraulic Report

---

TS&L Summary Letter

Report of Foundation Investigation (see Examples 1 and 2 in this appendix)

For Structure Chosen at TS&L

Final Hydraulic Design Report

Final Hydraulic Data Sheet (use current data sheet found in the folder "000 LGA General Info and Docs" located on the LGA SFTP site)

Hydraulic model with existing and proposed conditions

Scour memo, scour calculations, and berm slope protection recommendations (Bridges Only)

Plan/profile, general drawing sketches, and riprap layout as selected during the TS&L

Review Plans (100% complete & ready for review) in PDF Format

Design calculations, independent design check, and load ratings

---

To be submitted after plan review is complete

All Plan Review Comments must be Addressed and Documented

Final Plans – Electronic PDF file of the engineered, stamped set of plans

Construction Management Plan



**REPORT OF FOUNDATION INVESTIGATION**

**PROJECT:** BRO 8048(03) Mellette County PCN 02DY

**LOCATION:** Structure No. 48-102-010, 18.9 miles North & 0.8 miles West of Cedar Butte over the White River.

**METHOD OF INVESTIGATION:**

All soundings are made according to the Standard South Dakota Subsurface Investigation Techniques and AASHTO Specifications. Auger holes are drilled with a 4-1/2 inch continuous flight auger. Penetration and Push Test holes are drilled with a 6-5/8 inch continuous hollow stem auger. Push core samples are obtained by hydraulically ramming a 2 foot long lined split spoon sampler into the soil to obtain 2 inch nominal diameter soil samples. Penetration tests are conducted by dropping a 140 pound hammer 30 inches to obtain 2 inch nominal diameter samples and to measure the resistance to penetration of the soil. Corings with the SDDOT drive rig are performed by using a California retractable plug sampler, which is driven with a 490 pound hammer. The drill stem is P.K. rod, which is 2-7/8 inch O.D., and 2 inch nominal diameter cores are obtained. All laboratory tests are performed in accordance with standard AASHTO or SDDOT laboratory procedures.

**RECOMMENDATIONS:**

Abutments:

I. Steel HP10 X 42 Piling

A. A LRFD maximum factored pile bearing resistance of 77 tons can be used for design.

B. The anticipated tip elevations are:

<u>Station</u>	<u>Elevation</u>
22+06	1910
25+27	1892

C. The nominal pile bearing resistance shall be 192 tons verified by the SDDOT's Modified ENR formula.

Bents:

I. Drilled Shafts

A. A LRFD maximum factored resistance value of 2,800 psf can be used for design below elevation 1912 ft. or maximum scour whichever is lower.

B. Permanent casings will be required to elevation 1915 ft.

C. The point of fixity within the bedrock can be assumed to be the elevation 1912 ft.

**DISCUSSION:**

The proposed structure location is underlain by brown sand-silt (alluvium) overlying brown silt-sand with gravel (alluvium). The alluvial sediments rest upon gray silt-clay (Pierre Shale). The D50 of the brown sand-silt, brown silt-sand with gravel, and gray silt-clay (Pierre Shale) can be assumed to be 0.06 mm, 1.0 mm, and 0.004 mm. The D95 of the brown sand-silt, brown silt-sand with gravel, and gray silt-clay (Pierre Shale) can be assumed to be 1.0 mm, 6.0 mm, and 0.06 mm.

Steel HP10X42 piling along with the anticipated tip elevations, are listed in the recommendations for use in the abutments. Drilled Shafts are listed in the recommendations for use at the bents.

The piling were evaluated for drivability and group effects at the LRFD Strength Limit State. Settlement of the substructure units and horizontal movement of the abutment piling were evaluated at the LRFD Service Limit State.

Drivability –

## Local Bridge Improvement Grant (BIG) Procedure

A drivability analysis was performed for the steel HP10X42 piling using the wave equation analysis program (GRLWEAP). A group of pile hammers that were evaluated and found to produce acceptable driving stresses is listed later in this report for inclusion in the plans.

### Pile Group Effects:

#### Axial Loading – Abutments

For a single row of piling, AASHTO requires the center-to-center pile spacing to be at least 30" or 2.5 times the width of the pile, whichever is greater. Therefore, for the steel HP10x42 piling at the abutment the center-to-center spacing shall be at least 30".

#### Settlement –

The steel pile tips will be founded in the Pierre Shale. Unconfined compression test results of the Pierre Shale exceed the proposed bridge loadings. Past experience for piling driven into hard shale soil bedrocks has shown little, if any, settlement has occurred. Therefore, 1/4 inch or less of total settlement can be used to design the substructure units.

#### Horizontal Movement –

AASHTO states that if the center-to-center spacing of the piling in the substructure unit is greater than 5 times the width of the pile then group effects can be ignored. Therefore, if the designed spacing is greater than 5 times the pile width a group efficiency factor of 1.0 can be used with no reduction in pile loading required. If this minimum pile spacing is not met a reduction factor will need to be calculated according to the AASHTO code.

Horizontal movement at the substructure units can be calculated using the following soil parameters:

Sand-silt (alluvium); phi angle = 24 degrees, cohesion = 50 psf, wet unit weight = 118 pcf  
Silt-sand with gravel (alluvium); phi angle = 32 degrees, cohesion = 0 psf, wet unit weight = 130 pcf  
Silt-clay (Pierre Shale); phi angle = 18 degrees, cohesion = 1,000 psf, wet unit weight = 130 pcf

For the drilled shafts, a LRFD maximum factored resistance value (skin friction) of 2,800 psf is recommended below elevation 1912 for the bents or maximum scour whichever is lower. The point of fixity within the bedrock can be assumed to be 1912 for the bents.

Each drilled shaft shall have a minimum of 3 access tubes for a shaft diameter of 3.0' and less. The number of access tubes needed shall be increased by 1 for each foot increase in shaft diameter above the 3.0'. The access tubes shall be furnished and installed according to the South Dakota Department of Transportation's 2004 Standard Specifications for Roads and Bridges. These access tubes shall be equally spaced in the shaft reinforcement prior to placing the reinforcement cage.

A representative of the [CONSULTING FIRM \(NAME AND NUMBER\)](#) shall be present during drilling operations to confirm the elevations provided in this report and to observe the placement of the drilled shafts. In addition to the notes below, contact the [CONSULTANT REPRESENTATIVE](#) for the most current drilled shaft construction notes to be included in the plans.

### **The following notes shall be placed in the plans:**

A drivability analysis was performed using the wave equation analysis program (GRLWEAP). The pile hammers listed below were evaluated and found to produce acceptable driving stresses. Pile hammers not listed will require evaluation and approval prior to use from the [CONSULTANT REPRESENTATIVE NAME AND PHONE NUMBER](#).

*Hammers need to be sized according to site specific soil parameters and structure design requirements. The following list of hammers is owned and readily available by contractors that do work in SD. Select and specify in the report which hammers are acceptable for use on individual projects.*

## Local Bridge Improvement Grant (BIG) Procedure

ICE 180	Delmag D12-42	FEC 1500	Delmag D16-32	Delmag D19-32
Delmag D19-42	MVE M-19	ICE 42S	MKT DE 42/35	APE D19-42
Delmag D25-32	Delmag D30-32	SPI D30	Delmag D46-32	

# Local Bridge Improvement Grant (BIG) Procedure

STATE OF	PROJECT	SHEET NO.	TOTAL SHEETS
S.D.			

Plotting Date: 03/26/2013

The Geotechnical Engineering Activity has on file all of the boring logs for this project. These logs and additional results of laboratory test, if any, are available for review at the Central Office in Pierre.

### LEGEND

- ⊕ Auger Test
- ⊙ Drive Test
- ∇ Water
- ⊖ Caved
- Penetration Test
- ▬ Sample Zone

Drive test are conducted by dropping a 490 pound hammer 30 inches to drive a 2 1/8 inch drill stem with attached retractable plug sampler for taking samples and to measure the resistance to penetration of the soil.

Auger holes are drilled with a 4 1/2 inch diameter continuous flight auger. Penetration and Push Test holes are drilled with a 6 3/8 inch diameter hollow stem auger. Push core samples are obtained by hydraulically ramming a 2 foot long lined split spoon sampler into the soil to obtain 2 inch nominal diameter soil samples.

### GROUND WATER ELEVATIONS

as of December 2012

T1	(Caved)	1931.3
T2	(Caved)	1910.9
T3	Dry	
T4		1929.7
T5		1926.9
T6		1928.9
T7		1930.2
T8		1929.1
T9		1930.0
T10		1929.3
T11	Dry	
T12		1929.8

### MEASURED SKIN FRICTION

	Elev	psf
T11	1924.0	2,193
T12	1907.3	1,214

BRD 8048(03) MELLETTIE COUNTY PCN 02DY  
18.9 MILES N. AND 0.8 MILES W. OF CEDAR BUTTE  
SECTION 28 TOWNSHIP 45 W. RANGE 31 W.  
OVER WHITE RIVER  
STR. NO. 48-102-010

Pierre Shale is a marine shale with a textural classification that varies from silt-clay to clay-silt. Color varies from buff gray to black. The formation may contain concretions zones that are normally thin but occasionally are massive. These zones may be considered hard and dense. Thin zones may be present that are cemented resulting in claystone or siltstone seams. Bentonite zones may be encountered but are normally less than one half inch thick. Nonweathered Pierre Shale is considered to be "Soft Rock".

Hole Number	Station	Depth	Soil Color	Classification	Strength (Q <sub>v</sub> )	Dry Density	Wet Density	Moisture	Pass No. 10	Pass No. 40	Pass No. 200	Sand Content	Silt Content	Clay Content
T2	21493	5.8	Brown	Sand-Clay	85.3	93.6	95.6	14.8	84.4	76.2	61.9	22.6	25.0	38.8
T3	23492	5.7	Brown	Silt	81.7	91.7	91.0	12.3	95.9	91.1	55.1	44.9	45.1	10.0
T4	23492	17.0	Brown	Sand	97.8	107.0	107.0	9.4	96.2	74.9	9.9	96.3	9.9	0.0
T5	21497	23.8	Gray	Clay	55.490	116.3	136.6	16.9	95.8	95.7	96.9	2.8	41.1	55.9
T6	23499	37.8	Gray	Clay	49.749	112.5	133.5	18.5	99.8	99.8	99.5	0.3	39.6	59.9

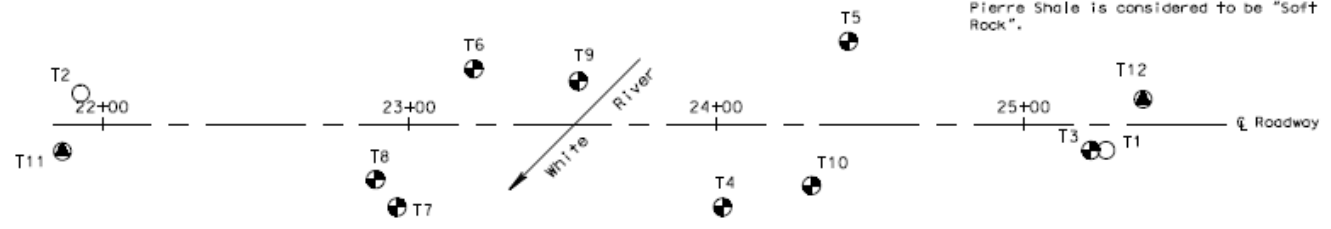

\* Values represent uncorrected "N" values from Penetration Test.

Sample Zone 48 Blows Per Foot

Bore holes on profile are moved slightly for clarity

Penetration tests are conducted by dropping a 140 pound hammer 30 inches to obtain 2 inch nominal diameter samples and to measure the resistance to penetration of the soil.

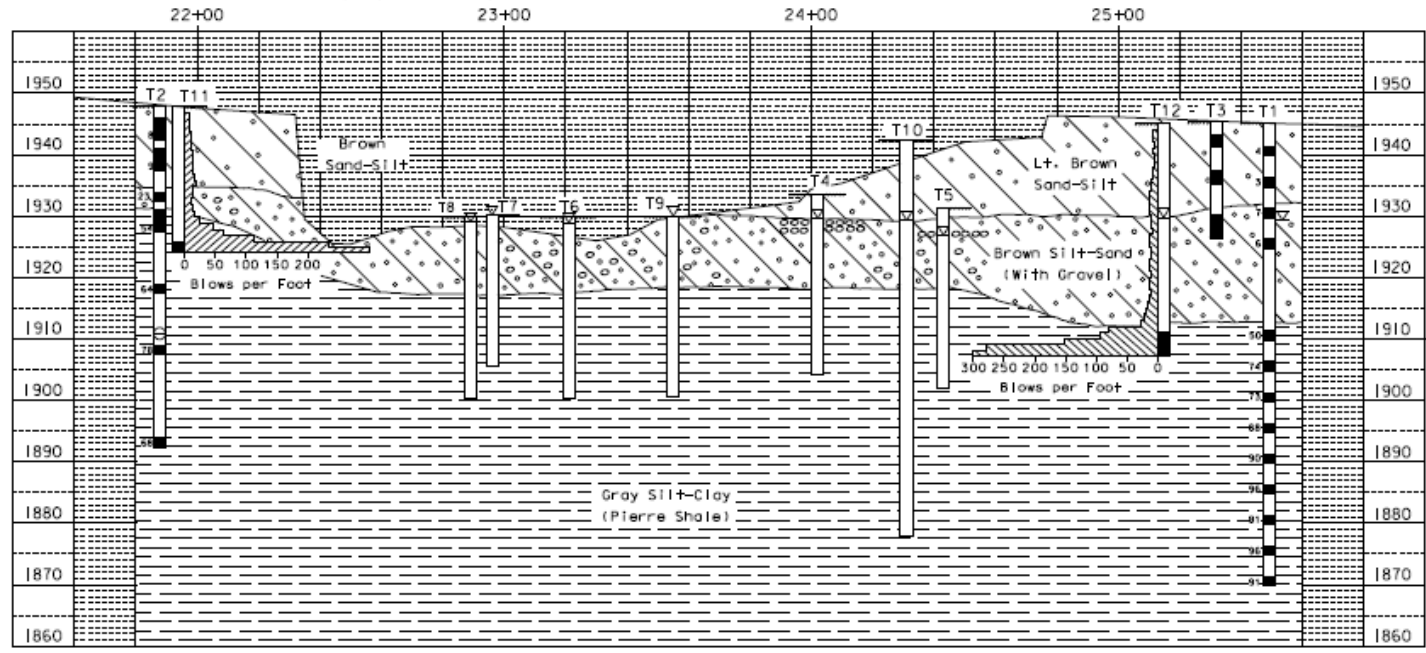

### SITE PLAN & SUBSURFACE PROFILE

DESIGNED BY	DRAWN BY	CHECKED BY	APPROVED
	NN	JW	

# Local Bridge Improvement Grant (BIG) Procedure

## RECOMMENDATIONS

## EXAMPLE 2

**Re:** BRO 8027(29), Gregory County, PCN 00QR  
Str. No. 27-030-081, located 2.0 West & 0.1 South of the Jct of SD44/SD47  
RCBC Undercut Recommendation

Soils maps of the area indicate the soils at the location of the proposed structure have the following characteristics.

Station 16+86 (Str. No. 27-030-081)

CLASSIFICATION: A-7  
Clay & Silty Clay  
AVERAGE LIQUID LIMIT: 66  
SHRINK-SWELL POTENTIAL: High to Very High  
FROST ACTION POTENTIAL: Low  
CORROSIVITY: High for steel, Low to Moderate for concrete

### RECOMMENDATIONS:

Provide 24 inches of undercut and backfill.

### DISCUSSION:

The project consists of replacing an existing single span 22' steel stringer bridge with a 2 barrel 13' x 6' cast-in-place RCBC. The proposed box culvert will be in the same location as the existing bridge location. The existing surfacing on the road is gravel and will be resurfaced with gravel upon completion. Minimal grading at the proposed box culvert location is anticipated, therefore, the material shall be compacted using the Ordinary Compaction Method.

A subsurface investigation was conducted for the proposed RCBC. The subsurface investigation consisted of placing a boring near both the proposed inlet and outlet ends of the structure and logging the material to 3 feet below the flow line. Samples were collected from below the flow line for soils classification. A dynamic cone penetrometer was used at both the inlet and outlet ends to identify the change in relative density of the subsurface material below flow line.

Subsurface soils at the proposed site consist of brown silt-clay to 3' below the existing flow line.

The 2' undercut depth is recommended to remove the low strength soils with high shrink-swell potential from below the box culvert.

### The following paragraphs shall be placed in the plans:

Compaction of earth embankment and box culvert backfill material shall be governed by the Ordinary Compaction Method.

Any questions about the recommendations or the subsurface conditions can be directed to the [CONSULTANT CONTACT NAME AND PHONE NUMBER](#).

**Appendix D - Construction Engineering Requirements**  
**Initial NBI Inspection Requirement - D2**  
**Construction Management Plan - D3 thru D9**

## Bridge Improvement Grant

### Initial NBI Inspection Requirement

The County / City will require the construction engineering firm or their subconsultant, either of which must be on the SDDOT's current consultant retainer for local bridge inspection, to perform an initial NBI inspection of the structure, ensuring a qualified Team Leader is on site for the inspection. Within 90 days of the structure being opened to traffic, the County / City will submit the completed report, BrM coding sheets, plans, applicable load ratings, and approved shop plans for girders, reinforced concrete box culverts, and other applicable items, to the SDDOT's LGA Bridge Inspection Engineer.

**Use and Limitation:** The Consultant shall use this document as a guide in preparing a construction management plan to be included in the bid documents for their specific project. Consultants are cautioned that the provision of this suggested sample construction management plan is not an implied or explicit guarantee of grant obligation compliance. The Consultant is solely responsible for the preparation and submittal of compliant construction management plan in accordance with the grant conditions. ONLY INCLUDE PROJECT SPECIFIC INFORMATION.

# Construction Management Plan

*[Date]*

*[Location]*

*[Project Number]*

*[PCN Number]*

**Prepared For**

*[       ]*

**Prepared By**

*[       ]*



## PROJECT INFORMATION

This Construction Management Plan (CMP) details the measures and procedures required to assure compliance with the quality assurance and acceptance provisions of the Bridge Improvement Grant construction contract for Project No. [ ] with **[County or City name]. South Dakota**. The work to be accomplished in this project consists of:

PROJECT SPONSOR: ***[Name & contact information for sponsor]***

CONTRACT  
ADMINISTRATION: ***[Name of firm Responsible for Const. Observation & QA testing]***

***[Name of QA firm]*** – Field tests

***[Name & contact info for QA lab]*** – Lab tests

## **RESPONSIBILITIES**

### ***Project Manager/Engineer***

The Project Manager / Engineer, on behalf of the sponsor is the person with overall responsibility for contract administration of this project. The Project Manager / Engineer has the authority to take the necessary actions to monitor compliance with the contract documents.

### ***Construction Observer***

The responsibilities of the Construction Observer shall include monitoring all aspects of the job, sampling materials for acceptance, conducting tests on embankment and excavation areas, reviewing and analyzing all test results, assuring that work is within specification limits, advising the Contractor's Superintendent and Project Engineer of nonconformance and possible corrective actions, and measuring quantities for payment.

### ***Quality Acceptance Laboratory***

[As appropriate, clarify which firm is responsible for what QA duties], testing lab duties shall include sampling materials for acceptance and conducting tests on: [embankment, excavation, subbase, base, rip rap, class A45 concrete, pile, PCC]. (If responsibilities for testing of materials are split between different organizations, list which firm is responsible for which QA tests.)

[QA Lab name] personnel assigned to construction testing have received certified training from the [Name of appropriate certifications] (e.g. Troxler Nuclear Equipment Seminar and the American Concrete Institute (ACI)).

All QA testing shall be performed by an (ASTM C1077 and D3666) accredited laboratory and a copy of the current accreditation shall be supplied to the Engineer and Owner, for approval, prior to submitting test results.

## QUALITY ASSURANCE INSPECTION PROCEDURES

1. Quality Assurance Tests: A list of tests and certifications required by the contract specifications can be found in the attached Appendix A. The list includes the referenced specification section and testing requirements. All parties will be informed of their responsibilities. This information will be reviewed at the preconstruction conference and monitored throughout the project.
2. Submittals: The Engineer shall maintain a file containing certifications and submittals required by contract as provided by the contractor, as well as approvals from the Engineer.
3. [Names of firm(s) responsible for QA test reports] will provide acceptance test reports to the [Owner / Engineer] as soon as the results are available, electronically. Typed copies shall be made available within [one] working day [delivered via electronic mail].
4. Material Test Reports: Material test results shall be verbally made available to the [Owner / Engineer] within [one hour] after the test report is completed and typed copies shall be made available within one working day [delivered via electronic mail].
  - Calibration check on equipment used to determine the noncompliance item, if applicable.
  - Confirmation of noncompliance through retesting and/or follow-up observations.
  - If a solution to the nonconformance issue is not reached in a reasonable time frame, additional qualified contractor personnel will be contacted to assist in identifying and correcting the problem.
  - If a severe nonconformance problem is detected and a reasonable solution cannot be implemented in a reasonable time frame, the Construction Superintendent will consult with the Project Engineer and the work will be suspended.
  - The work will not begin again until the Construction Superintendent and Project Engineer concur that a solution to the problem has been found and successfully implemented.
5. Test Reports Which Require Corrective Actions: Should test results or observations indicate noncompliance with the project contract, plans, or specifications, the following communication and follow-up action will be implemented, as applicable:
  - Verbal notification to the sponsor, Construction Superintendent, work area foreman and/or plant operator.

## Local Bridge Improvement Grant (BIG) Procedure

- On restarting the work, the nonconforming testing element or observation will be monitored at an appropriate higher frequency for a reasonable amount of time, e.g. double the testing frequency listed.
  - After the area in noncompliance has been repaired, acceptance retesting will resume. The test reports will include the failed test number for tracking.
6. Daily Reports: The project manager or his representative will maintain a daily diary summarizing pertinent construction items. Items recorded shall include (as a minimum):
- a) Date
  - b) Weather Conditions
  - c) Brief Summary of Work Performed
  - d) Number of workers on site
  - e) Type and Amount of Major Equipment being utilized
  - f) Running total of working/calendar days used on project
  - g) Significant Directives/Communication with contractor (e.g. regarding construction procedures or material quality)
  - h) Summary of QA tests performed that day
  - i) Arrival / Departure Time of On Site Inspection Staff
7. Bi-Weekly Reports: A summary of bi-weekly construction status shall be prepared and submitted to [owner] every [list day, e.g. Friday]. Report shall include summary of work completed in that 2 week period, summary of QA test results, discussion of any controversial issues that came up, and work anticipated during next reporting period. A sample report is included in Appendix B.
8. The resident observer and acceptance testing lab personnel shall maintain all acceptance test reports and provide copies to the owner/engineer as soon as results are available.
9. [Name of firm responsible for final construction report] will prepare a final project construction material testing and acceptance report that includes a summary of: all acceptance tests results, quantity of materials, and all bi-weekly reports. (Actual test reports will be available upon request). This will be submitted to the SDDOT with the final pay application.

Include listing of all QC/QA tests and certifications required by the contract specifications.

Recommend including the following information in your listing:

- Material
- Specification
- Specification reference section
- Test Required
- Minimum Testing Frequency
- Test Requirements
- Notes

Material	Specification	Spec Section	Test Required	Min. Test Frequency	Requirements	Notes
----------	---------------	-----------------	------------------	------------------------	--------------	-------



## **Appendix E - Bridge Improvement Grant Sign Layout**

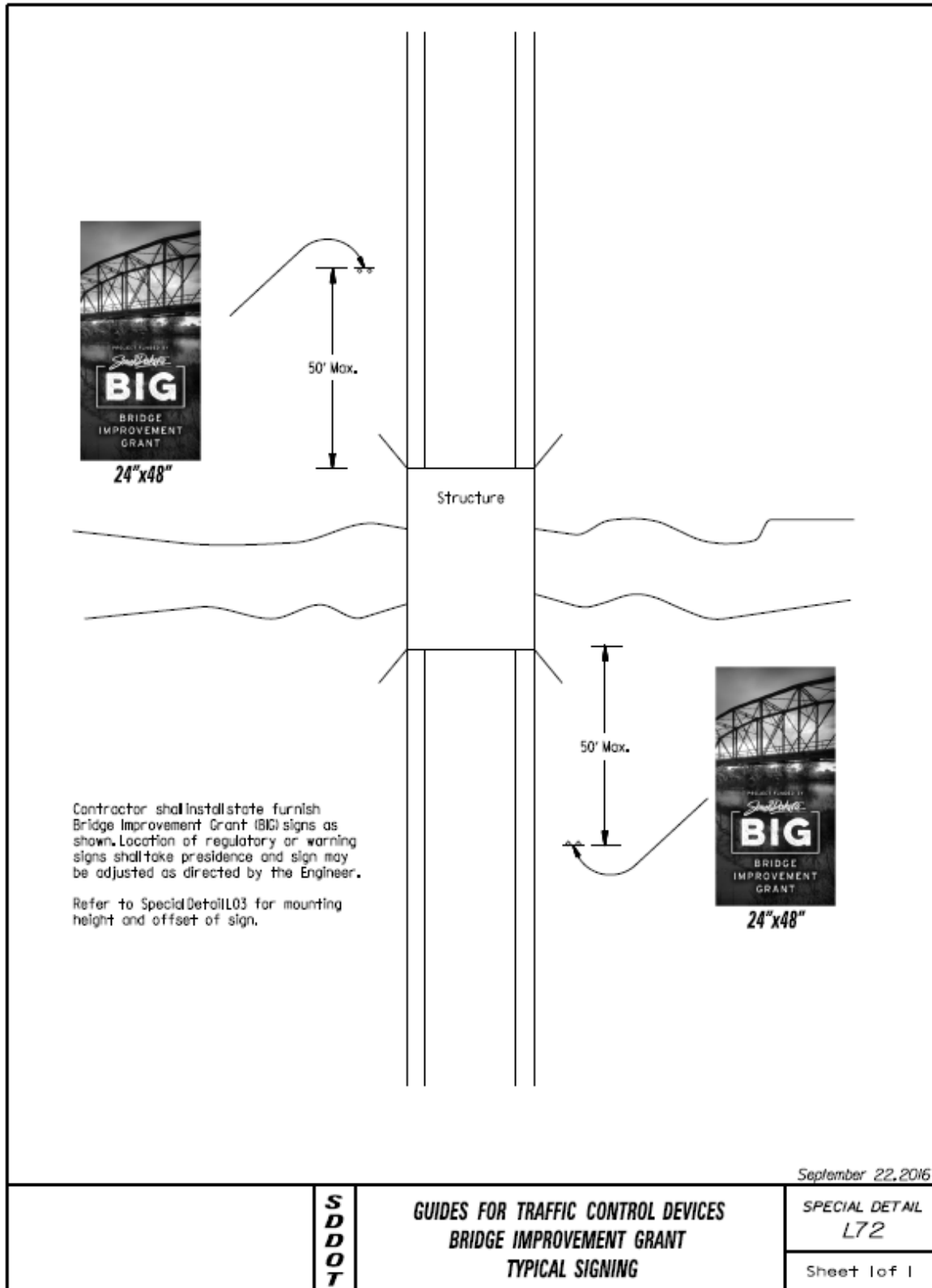



## **Appendix F – Bridge Improvement Grant Checklists**

## Bridge Improvement Grant - Local Administration Check List (Source of Info – BIG Procedures and BIG Funding Agreement)

Multiple grants can be let together but all estimates, bids, and payments must be sent to LGA **per grant (not combined)**. LGA Project Managers will keep the 'U' drive project folders current at all times with all project documents & e-mail correspondence as received in order to have everything available to staff if there are any questions and to help expedite reimbursements.

Responsibilities of County/City

- Hire a Professional Engineer (PE) from SDDOT Consultant Retainer Lists for Local Gov't or State Bridge Design Categories
  - o Prepare contract between county/city and consultant which must contain:
    - Scope of services & retainer requirements as included in DOT funding agreement (**NOTE: retainer requirements reflect the active retainer at the time the BIG Procedures for the applicable grant year are approved by the Transportation Commission**)
    - Reference must be made to the project number and/or structure number associated with the grant

### PRIOR TO ADVERTISEMENT

- Obtain and submit (as needed) to DOT for review (signed and sealed by a PE) LGA Project Managers – add following note to 1<sup>st</sup> page of all BIG BlueBeam reviews, “NOTICE: State forces, please charge time to BR BGPE(00)23-1, PCN 08A4.” (This # in effect only between 10/1/22 & 9/30/23 – contact N. Clocksin):
  - o Final Hydraulic Design Report, Final Hydraulic Data Sheet, Hydraulic model with existing and proposed conditions and if the bridge scour protection is needed, Scour Memo summarizing hydraulic scour calculation, Scour Calculation, and Berm Slope Protection Recommendations (if applicable) \*
  - o Foundations report (as defined in the funding agreement attachment); NOTE: firm must be on the SDDOT Consultant Retainer category for Local – Geotechnical Services \*
  - o review plans (100% complete – anything less won't be reviewed)
  - o bid documents / specifications (only engineer's construction estimate and any special out of the ordinary specs)
  - o design calculations, scour analyses \*, load rating and analysis for bridge inspection file
  - o all necessary permits
    - Corp of Engineers 404 Permit \*, DOT/LGA Utility Cert, DOT/LGA ROW Cert, Federal Lands, BIA, Tribal, Stormwater, Municipal, etc.
  - o BIG Construction Management Plan
  - o Draft contract (showing hours) for construction engineering & Initial NBI Inspection – consultant must be a PE selected from the SDDOT Consultant Retainer List for State Construction Administration to do Construction Engineering & consultant or their subconsultant must be on the SDDOT Consultant Retainer List for Local Bridge Inspection to do the Initial NBI Inspection.
- Obtain DOT approval letter to advertise (**All applicable documents noted above must be revised as needed and approved by DOT before this letter will be sent from the DOT**)
- Advertise project for bids and conduct bid letting

\* Not applicable in all cases (for example, simple deck overlay)

### PRIOR TO SIGNING CONTRACT WITH CONTRACTOR

- Submit to DOT for review bid tabulation showing engineer's estimate and all bidders, in addition to the county/city's recommendation for award
- Obtain DOT bid concurrence letter

### AFTER DOT BID CONCURRENCE

- Enter into construction & construction engineering contracts and issue notice to proceeds
- Submit copies of both contracts to DOT for release of 75% of the grant fund portion of the combined total of the contract amounts
- Obtain and supply to DOT as-built plans and notification of completion of project
- Submit all design, construction, and CE billings to DOT for reimbursement of remaining grant funds

## REIMBURSEMENT PROCESS

### Bridge Improvement Grant - Local Administration Check List

#### (Source of Info – BIG Procedures and BIG Funding Agreement)

Multiple grants can be let together but all estimates, bids, and payments must be sent to LGA per grant (not combined)

Responsibilities of County/City

- Submit to DOT for Reimbursement of **Design Billings**
  - Copy of signed design contract must accompany first billing by county/city
  - “BIG Direct Payment Invoice” must accompany each billing
  - Copy of bill(s) from consultant
  
- Submit to DOT for Payment 75% of BIG share for **Construction & Construction Engineering**
  - Copy of signed construction contract and signed construction engineering contract

## FINALLING PROCESS

### Bridge Improvement Grant - Local Administration Check List

#### (Source of Info – BIG Procedures and BIG Funding Agreement)

Multiple grants can be let together but all estimates, bids, and payments must be sent to LGA per grant (not combined)

Responsibilities of County/City

- Submit to DOT for Reimbursement a FINAL **Design Billing**
  - Submit “BIG Direct Payment Invoice” with Final Billing box checked (blue box on lower right)
  - Copy of bill(s) from consultant
  
- Submit to DOT for Reimbursement a FINAL **Construction Engineering (CE) Billing** – *NOTE: CE billings must be processed separately from design billings as CE does not count against the grant cap.*
  - Submit “BIG Direct Payment Invoice” with Final Billing box checked (blue box on lower right)
  - Copy of bills(s) from consultant
  
- Submit to DOT copy of testing documents as defined in the BIG Construction Management Plan prior to or with FINAL Contractor Billing
  
- Submit to DOT for Reimbursement a FINAL **Contractor Billing**
  - Submit “BIG Direct Pymts Invoice” with Final Billing box checked (blue box on lower right) for Construction along with copies of all billings from contractor
    - Any applicable Change Orders must be sent in as well, as approved and signed by contractor, consultant, and county/city

## Bridge Improvement Grants

### LOCATION OF DOCUMENTS

Document	LGA Location	External Location for Download
SDDOT Consultant Retainer Lists for Local Gov't or State Bridge Design and Local Gov't Geotechnical Services	<a href="https://dot.sd.gov/doing-business/engineering/design-services/consultant-services">https://dot.sd.gov/doing-business/engineering/design-services/consultant-services</a>	<a href="https://dot.sd.gov/doing-business/engineering/design-services/consultant-services">https://dot.sd.gov/doing-business/engineering/design-services/consultant-services</a>
BIG Scopes of Services	M:\DOT\FPA\LGA\Project_Info_&_Funding\Forms\Scopes of Services & Current Retainer List\03 Structure Scopes\BIG Scopes	<i>Not Available – Generated by LGA Project Manager</i>
DOT Utility Cert for BIGs	M:\DOT\FPA\LGA\Project_Info_&_Funding\Forms\Certifications & ROW Forms \ <b><i>“BIG Utilities Cert”</i></b>	Request from any LGA staff member – can be e-mailed or placed in a firm's LGA SFTP folder.
DOT Right-of-Way Cert for BIGs	M:\DOT\FPA\LGA\Project_Info_&_Funding\Forms\Certifications & ROW Forms \ <b><i>“BIG ROW5-CERT” or “BIG No ROW Needed Cert”</i></b>	Request from any LGA staff member – can be e-mailed or placed in a firm's LGA SFTP folder.
BIG Construction Management Plan	M:\DOT\FPA\LGA\Project_Info_&_Funding\Forms\BIG Construction Management Plan Template \ <b><i>“BIG Construction Management Plan”</i></b>	Request from any LGA staff member – can be e-mailed or placed in a firm's LGA SFTP folder.
DOT BIG Letting Authorization	M:\DOT\FPA\LGA\Project_Info_&_Funding\Forms\BIG Let Auth and Concur in Award of Letting \ <b><i>“BIG Letting Authorization”</i></b>	<i>Not Available – Generated by LGA Project Manager</i>
DOT BIG Award Concurrence	M:\DOT\FPA\LGA\Project_Info_&_Funding\Forms\BIG Let Auth and Concur in Award of Letting \ <b><i>“BIG Award Concurrence”</i></b>	<i>Not Available – Generated by LGA Project Manager</i>
BIG Direct Pymts Invoice (NOTE: File contains worksheets for Prel. Engr., Construction Engr., and CONSTRUCTION BILLINGS)	M:\DOT\FPA\LGA\Project_Info_&_Funding\Forms\BIG PE CE & Construction Reimbursement Docs\ <b><i>“BIG Direct Pymts Invoice PCN”</i></b>	Request from any LGA staff member – can be e-mailed or placed in a firm's LGA SFTP folder.
Pay Est SHELL BIGs (Submitted with Constr. Billing BIG Direct Pymts Invoice noted above.)	M:\DOT\FPA\LGA\Project_Info_&_Funding\Forms\BIG PE CE & Construction Reimbursement Docs\ <b><i>“Pay Est SHELL BIGs”</i></b>	Request from any LGA staff member – can be e-mailed or placed in a firm's LGA SFTP folder.
LGA Bridge Networks (Shows Potential Timeline of each type of BIG)	M:\DOT\FPA\LGA\Project_Info_&_Funding\Forms\Bridge LGA Bridge Networks\ <b><i>“LGA Bridge Network”</i></b>	Request from any LGA staff member – can be e-mailed or placed in a firm's LGA SFTP folder.
BIG CHECKLISTS	M:\DOT\FPA\LGA\Project_Info_&_Funding\Forms\BIG CHECKLISTS	(Provided to all consultants & local government with copy of BIG funding agreement.) Request from any LGA staff member – can be e-mailed or placed in a firm's LGA SFTP folder.